



AQM 1208

AquaControl

Zone Series

12 x 8 Audio Mixer

Operating Manual



Important Safety Instructions • *Consignes de sécurité à lire attentivement*



1. Read these instructions.
2. Keep these instructions.
3. Heed all warnings.
4. Follow all instructions.
5. To reduce the risk of fire or electric shock, do not expose this apparatus to rain or moisture.
6. Do not use this apparatus near water.
7. Clean only with dry cloth.
8. Do not block any ventilation openings. Install in accordance with the manufacturer's instructions.
9. Do not install near any heat sources such as radiators, heat registers, stoves, or other apparatus.
10. Do not defeat the safety purpose of the polarized or grounding-type plug. A polarized plug has two blades with one wider than the other. A grounding type plug has two blades and a third grounding prong. The wide blade or the third prong are provided for your safety. If the provided plug does not fit into your outlet, consult an electrician for replacement of the obsolete outlet.
11. Protect the power cord from being walked on or pinched particularly at plugs,

The lightning flash with arrowhead symbol, within an equilateral triangle, is intended to alert the user to the presence of uninsulated "dangerous voltage" within the product's enclosure that may be of sufficient magnitude to constitute a risk of electric shock to persons. The exclamation point within an equilateral triangle is intended to alert the user to the presence of important operating and maintenance instructions in the literature accompanying the device.

- convenience receptacles, and the point where they exit from the apparatus.
12. Only use attachments/ accessories specified by the manufacturer.
 13. Use only with the cart, stand, tripod, bracket, or table specified by the manufacturer, or sold with the apparatus. When a cart is used, use caution when moving the cart/ apparatus combination to avoid injury from tip-over.
 14. Unplug this apparatus during lightning storms or when unused for long periods of time.
 15. Refer all servicing to qualified service personnel. Servicing is required when the apparatus has been damaged in any way, such as power-supply cord or plug is damaged, liquid has been spilled or objects have fallen into the apparatus, the apparatus has been exposed to rain or moisture, does not operate normally, or has been dropped.

Le symbole de la foudre dans un triangle équilatéral symbolisant la foudre est prévu pour sensibiliser l'utilisateur à la présence de tension de voltage non isolée à l'intérieur de l'appareil. Elle pourrait constituer un danger de risque de décharge électrique pour les utilisateurs. Le point d'exclamation dans le triangle équilatérale alerte l'utilisateur de la présence de consignes qu'il doit d'abord consulter avant d'utiliser l'appareil.

1. Lisez ces instructions.
2. Conservez ces instructions.
3. Observez les avertissements.
4. Suivez ces instructions.
5. Pour réduire le risque de feu ou la décharge électrique, ne pas exposer cet appareil pour pleuvoir ou l'humidité.
6. Ne pas utiliser l'appareil près de l'eau.
7. Le nettoyer à l'aide d'un tissu sec.
8. Ne pas bloquer les ouvertures de ventilation, installer selon les consignes du fabricant.
9. Eloigner des sources de chaleur tel: radiateurs, fourneaux ou autres appareils qui produisent de la chaleur.
10. Ne pas modifier ou amputer le système de la mise à terre. Une prise avec mise à terre comprend deux lames dont une plus large ainsi qu'une mise à terre: ne pas la couper ou la modifier. Si la prise murale

n'accepte pas la fiche, consulter un électricien pour qu'il remplace la prise désuète.

11. Protéger le cordon de secteur contre tous bris ou pincement qui pourraient l'endommager, soit à la fiche murale ou à l'appareil.
12. N'employer que les accessoires recommandés par le fabricant.
13. N'utiliser qu'avec les systèmes de fixation, chariots, trépied ou autres, approuvés par le fabricant ou vendus avec l'appareil.
14. Débrancher l'appareil lors des orages électriques ou si inutilisé pendant une longue période de temps.
15. Un entretien effectué par un centre de service accrédité est exigé si l'appareil a été endommagé de quelque façon: si il a été exposé à la pluie,, l'humidité ou s'il ne fonctionne pas normalement ou qu'il a été échappé.

WARNING: THIS APPARATUS MUST BE GROUNDED (EARTHED)

FCC Compliance

This device complies with part 15 of the FCC Rules. Operation is subject to the following two conditions:

- This device may not cause harmful interference
- This device must accept any interference received, including interference that may cause undesired operation

Note: This equipment has been tested and found to comply with the limits for a Class B digital device, pursuant to part 15 of the FCC Rules. These limits are designed to provide reasonable protection against harmful interference in both a commercial and residential installation. This equipment generates, uses and can radiate radio frequency energy and, if not installed and used in accordance with the instructions, may cause harmful interference to radio communications. However, there is no guarantee that interference will not occur in a particular installation. If this equipment does cause harmful interference to radio or television reception, which can be determined by turning the equipment off and on, the user is encouraged to try to correct the interference by one or more of the following measures:

- Reorient or relocate the receiving antenna.
- Increase the separation between the equipment and receiver.
- Connect the equipment into an outlet on a circuit different from that to which the receiver is connected.
- Consult the dealer or an experienced radio/TV technician for help.

Unpacking

As a part of our system of quality control, every Ashly product is carefully inspected before leaving the factory to ensure flawless appearance.

After unpacking, please inspect for any physical damage. Save the shipping carton and all packing materials, as they were carefully designed to reduce to a minimum the possibility of transportation damage should the unit again require packing and shipping. In the event that damage has occurred, immediately notify your dealer so that a written claim to cover the damages can be initiated.

The right to any claim against a public carrier can be forfeited if the carrier is not notified promptly and if the shipping carton and packing materials are not available for inspection by the carrier. Save all packing materials until the claim has been settled.

About Ashly

Ashly Audio was founded in 1974 by a group of recording engineers, concert sound professionals, and electronics designers. The first products were elaborate custom consoles for friends and associates, but business quickly spread to new clients and the business grew.

The philosophy we established from the very beginning holds true today: to offer only the highest quality audio tools at an affordable cost to the professional user – ensuring reliability and long life. Years later, Ashly remains committed to these principles.

Ashly's exclusive five-year, worry-free warranty remains one of the most generous policies available on any commercial-grade product. The warranty covers every product with the Ashly brand name, and is offered at no extra cost to you.

Please read this entire manual to fully understand the features and capabilities of this product.

Table of Contents

1	Introduction	6	AquaControl Software	8	Meters
1.1	Product overview		AquaControl Portal AQM1208 ...		
1.2	Product features		Firmware update Instructions		
2	Installation Requirements ...	6.1	Dashboard		9
2.1	Electrical and wiring	6.1a	Launch quick setup		Troubleshooting
2.2	Mechanical	6.2	Signal chain		10
2.3	Network	a.	Mic/Line inputs 1-12		Dimensions
2.4	Browser & resolution	b.	Mixers 1-8		11
3	Front Panel Features	c.	Line Outputs 1-8		Specifications
3.1	Mounting holes	d.	Presets & Templates		AquaControl™ software
3.2	COM LED	e.	DSP function blocks		12
3.3	Power LED		Autoleveler		Limited Warranty
3.4	Status LEDs		Brick wall limiter		
4	Rear Panel Features		Compressor		
4.1	Mic/line inputs		DCA gain		
4.2	Summed Mono Inputs		Delay		
4.3	Device Reset Switch		Feedback suppressor ...		
4.4	Balanced Line Outputs		Gain		
4.5	VCA Remote Level Control .		Gate		
4.6a	Trigger inputs 1-8		High-pass filter		
4.6b	GPO Outputs 1 & 2		Low-pass filter		
4.7	Ethernet Port		Parametric equalizer		
4.8	MAC Address		Signal generator		
4.9	AC Inlet		VCA gain		
5	Network Discovery		Ambient noise comp		
5.1	Windows		Crossover		
5.2	OSX		FIR filter		
5.3	iOS				
5.4	ANDROID				
5.5	What if Discovery Fails?				
		h.	Mixers/Automixer		
		i.	Ducking		
		j.	Routing		
		6.3	Settings		
		a.	General settings		
			Import/Export settings .		
			Firmware update		
			Real time clock		
		b.	Panels > Front panel		
			Enable Front LEDs		
			Enable power on/off		
		d.	Panels > Rear panel		
			Mic input LEDs		
			Mic phantom pwr		
			Mic preamp gain		
			VCA input status		
			Trigger input pin status .		
			GPO pin toggle		
		e.	Network		
			DHCP config		
			Static IP config		
			MAC address		
			Identify Device		
		f.	Security		
			Admin		
			Guest admin		
			Operator		
			View only		
		6.4	Events		
			Event list		
		a.	Scheduled events		
		b.	Triggered events		
		7	Remote Control		
		7.1	Software remote control		
		a.	Remote mixer 1-8		
		b.	Remote DCA 1-4		
		c.	Virtual remote WR5		
		7.2	Back panel remote control ..		
		a.	VCA level control		
		b.	Trigger logic inputs		
		c.	GPO logic outputs		
		7.3	Ashly remotes		
		a.	AquaTouch7		
		b.	WR-1.0 and WR-1.1		
		c.	WR-1.5		
		d.	WR-2		

1 Introduction

Thank you for your purchase of the AQM1208 DSP Mixer. This product combines 12 balanced mic/line inputs, four stereo RCA summed mono inputs, and eight balanced line outputs. Matrix mixing with comprehensive DSP processing allows custom designed installations. In addition, there are eight VCA remote level control inputs, eight multi-purpose trigger inputs, and two logic outputs for remote control use.

DSP processing including advanced ducking, matrix mixing, feedback suppression, tone generation, integrated Ethernet control using Ashly AquaControl™ software, remote control, triggered/scheduled events, and much more. Please read this entire manual to fully understand the features and capabilities of this product.

1.1 Product Overview

Each mixer front end input channel uses high quality mic/line inputs. Additionally, inputs 9-12 accept summed mono RCA inputs in addition to the mic/line inputs.

The AQM1208 provides eight balanced line outputs, each with its own routing matrix and mixer.

DSP includes matrix routing and mixing per output, advanced ducking, feedback suppression, EQ, FIR filters, limiting/compression, noise gates, automixing, autoleveling, ambient noise compensation, crossover, delay, and more. Additional features include event scheduling/triggering, remote control, event based logic outputs, and more.

The AQM1208 is configured and controlled using server-based Ashly AquaControl™ software, compatible with most browser enabled devices. AquaControl is served from the AQM1208, installing an application on your computer, phone, or tablet is unnecessary.

1.2 Product Features

- 12 balanced Mic/Line inputs with phantom power, plus four summed mono -10dBV RCA inputs available on channels 9-12
- 8 independent mixers with matrix routing
- Ashly AquaControl software served directly from the AQM1208, runs on most web-browsers, no app to install. (for offline setup or exploring the software, download "AquaControl Portal AQM1208" Windows app from the Ashly website.)
- Password protected security roles for admin, guest admin, operator, view only
- Secure, custom GUI remote control options, deployable to browser-equipped devices
- Create presets, sub-presets, and templates
- Advanced ducking, feedback suppression, automixer, autoleveler, FIR filter, comp/limiter, EQ, crossover, & more
- Real-Time-Clock for scheduled events or event sequences
- Eight assignable VCA level control inputs
- Eight programmable triggered event logic inputs
- Two event and preset driven GPO logic outputs

- Front panel LEDs for Power, COM, Input, and Output channel status
- Certifications: FCC, CE, RoHS
- Ashly five year worry-free warranty

2 Installation Requirements

2.1 Electrical and Wiring

The AQM1208 is designed with a universal power supply, compatible with 100-240VAC, 50-60Hz. Always use the power cord supplied with your unit. Do not remove AC ground.

Always use high quality shielded cable for input signals, and use a balanced input signal when possible. To avoid possible system noise or oscillation, avoid running low level signal wires parallel to speaker outputs or AC wiring, especially over long distance. Before testing the system, double check all connections and settings. Refer to the specifications section of this manual for input, output, Ethernet, and other amplifier properties to consider during installation.

2.2 Mechanical

The AQM1208 is 1RU, and is designed to fit in a standard 19-inch equipment rack. Use four screws when mounting the product to the front rack rails. (see [mechanical drawing](#)).

2.3 Network

The AQM1208 is compatible with 10MB, 100MB, or 1GB Ethernet. Connect its Ethernet jack to a network router, or connect directly to a computer. A solid yellow LED on the Ethernet jack indicates a successful network connection. The green LED blinks to indicate network activity. If there is no LED connection or activity indicated, backtrack through cables, routers, or switches to find the problem. See [section 5](#) for detailed instructions on AQM1208 network discovery.

2.4 Browser and Resolution

Supported browsers include Chrome, Edge, and Safari. The software requires a minimum screen resolution of 1024 x 768. For best experience, a minimum screen size of 10" is recommended.

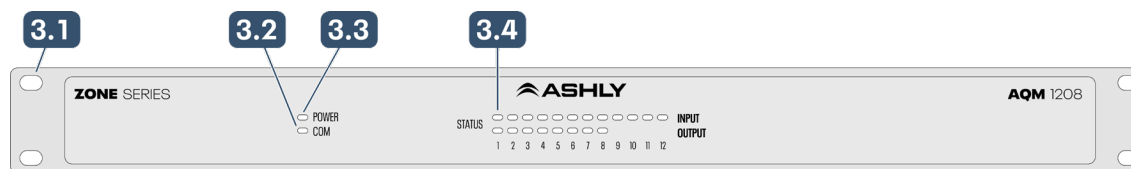

3 Front Panel Features

3.1 Mounting Holes

For rack mounting. Always use all four mounting holes.

3.2 COM LED

This LED indicates that network communications is occurring. It will also light up for 10 seconds whenever the software's "Identify Device" function is selected in the "Settings> Network" page.

3.3 Power LED

The AQM1208 has no power switch. The unit can only be powered off using the Power On/Off button in "Settings>Panels" page, or by removing AC.

3.4 Status LEDs

Input channel LEDs sample the audio signal after the input preamp gain stage, but before the input signal chain DSP. Input LEDs turn green to indicate signal present (-20dBu), amber at +10dBu, and red to indicate max level (+20dBu). They also turn red if the input channel has been muted.

Note: Mixer mute (see [section 6.2h](#)) does not light channel mute LEDs. Mixer mute status is only indicated in the software mixer page.

Output channel LEDs are post-DSP. They turn green to indicate output signal present (-20dBu), amber at +10dBu, and red to indicate max level. They also turn red if the output channel is muted.

In addition, the status LEDs are used to display progress during either an admin reset or a full factory default reset. See [section 4.3](#) for admin or factory default reset details.

4 Rear Panel Features

4.1 Balanced Mic/Line Inputs 1-12

Use for wiring 3-wire balanced inputs (+, -, G) using the provided Euroblock connectors. If an *unbalanced* input signal is used, wire its hot signal to (+), its ground to (-), and leave the AQM1208 input ground pin for that channel unconnected. Maximum input level is +21 dBu.

4.2 Summed Mono Inputs 9-12

These RCA jacks are typically used for stereo line level inputs (-10dBv). They share their summed signal with mic/line inputs 9-12. Unlike mic/line inputs 9-12 however, there are no input gain controls for the RCA inputs. They are summed with channel 9-12 mic/line preamp outputs before any DSP processing.

Note: Unbalanced line level sources may reference their outputs to a different ground than this amplifier, creating the potential for ground loop hum. Always use short cable lengths for unbalanced signals, routed away from AC, video, or data cables, and make every effort to use a common grounding point for all devices. In the event there is still ground loop hum, isolate the unbalanced input signal by using an in-line isolation transformer.

4.3 Device Reset Switch

There are two levels of reset, *Admin* and *Factory Default*. The time this switch gets pressed during a *cold-boot* power-up determines the level of reset. **A cold-boot power-up is when AC power is removed, then re-applied while pressing and holding the reset switch.**

To initiate a reset, first press and hold the reset switch using a pencil-tip or similar object, then re-apply AC power while viewing the front panel status LEDs.

table of contents

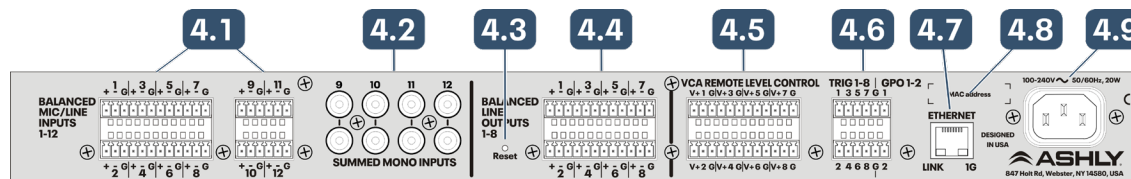

Once the reset process begins, input LEDs 1-12 will turn green in sequence starting with channel 1 and progressing through channel 12, followed by output LEDs 1-8. The level of reset, whether admin or factory, is determined by when the reset switch is released during this sequence. **To cancel reset, release the switch before all 12 input LEDs are lit.** The two reset types are explained further below:

1) Admin Reset: This restores the admin user password with <secret>, but preserves all other user IDs/passwords, presets, and settings. Use this level if you forgot your password. Note: This also resets the IP configuration to Automatic (DHCP/Linklocal), clearing any Static IP setting that may have been entered.

To perform an Admin reset, release the reset switch after all 12 Input LEDs turn on, but before all eight output LEDs turn on.

2) Factory Default Reset: This deletes all user IDs and passwords, deletes all presets and events, and restores all settings to factory default. Use this to completely scrub the device clean of any previous programming.

To perform a Factory Default reset, release the switch within three seconds after all eight output LEDs have turned on. Holding the switch for longer than three seconds will exit reset, resulting in no action taken.

4.4 Balanced Line Outputs 1 - 8

Eight output channels provide post-DSP signals for driving amplifiers or other processors. Outputs are configured in the [Signal Chain>Routing](#) section. Outputs are pseudo-

balanced, (single ended signal with balanced impedance). Maximum output level is +21 dBu.

4.5 VCA Remote Level Controls 1-8

A VCA (voltage controlled amplifier) is used to remotely control one or more [VCA gain blocks](#), which must first be added to the DSP signal chain in software. Ashly WR-1, WR-1.1, and WR-1.5 remotes are passive potentiometer remotes which can be wired to VCA input pins to control VCA gain. See [section 7](#) for example.

4.6a Trigger Inputs 1-8

Eight contact closure pins can be used to trigger user-defined events or event sequences. See [section 6.4](#) for details and available event action types.

4.6b GPO Outputs 1 & 2

These pins provide logic outputs, referenced to the ground pin found on the same connector. Logic output changes are generated from presets, triggers, or scheduled events, and can be assigned high or low. See [section 7.2c](#).

4.7 Ethernet Port

The RJ-45 connects to an Ethernet network or directly to a PC for Ashly AquaControl.

4.8 MAC Address

The device MAC address sticker is found here.

4.9 AC Inlet

Used for the detachable AC cord. Use only the factory supplied AC cord. **WARNING: Do not remove or lift the AC mains ground connection.**

5 Network Discovery

Ashly AquaControl compatible products have a built-in web server delivering software right to your computer or mobile device. AquaControl can connect to your device using an Ethernet/Wi-Fi router or via a direct Ethernet connection to your PC. AquaControl is accessed through the web browser on your device. Supported browsers include current versions of Chrome®, Edge®, and Safari®. For best results, Ashly recommends a minimum screen resolution of 1024 x 768, and screen size of 10" or larger.

Ethernet Connection:

AquaControl devices come configured with automatic IP assignment as the default, to ensure compatibility with your network/computer. This means you must initially connect its Ethernet jack to a network router for automatic IP assignment (DHCP), or alternatively connect it directly to a computer for automatic Link Local IP assignment. Once connected, you may access AquaControl software to change the connection to static IP, if desired.

Getting Started:

Apply power to the AquaControl device and router (if used), then boot your computer or mobile device. Wait a couple minutes for all devices to boot and establish network connections. Launch the web browser on your computer or mobile device and enter the AquaControl device's unique hostname address in the address bar. The format is `http://(device)_(mac address).local/`. The mac address can be found on a sticker on the back or side of the unit.

A hostname address for an Ashly AQM1208 would appear similar to: `http://aqm1208_0014AAF00036.local/`. Enter your device's hostname address into your browser to access the AquaControl login screen. Login using the factory default credentials, User ID: **admin**; Password: **secret**. If you are still unable to access the AquaControl login screen in your browser, try the alternate network discovery instructions shown below.

5.1 Windows®

1) Open File Explorer, (type "File Explorer" in the Windows search bar to find it). In the File Explorer app click on the "Network" section in the left side pane. A list of all connected network devices should begin populating. Wait for the list to complete and skip to step 3. If the list doesn't populate, you may have to right-click in the right side pane and select refresh or enable Windows Network Discovery - see step 2.

2) To enable Windows Network Discovery, click on the yellow warning message at the top of File Explorer's right side pane in the Network section. Repeat Step 1.

3) Your AquaControl device may appear in the "Other Devices" list (sometimes referred to as SSDP Plug'N'Play). The device MAC address is added to the end of it's name. The MAC address is printed on a sticker attached to the device back or side panel. Double-click on the device icon to automatically launch the software. If you do not see your device listed here, go to step 4, otherwise skip to step 7.

4) In certain cases, your AquaControl product will appear in the "Computer" section of the network list. If this is the case, double-click on it and proceed to step 5.

5) Double-click on the AquaControl shared folder and proceed to step 6.

6) Double-click on the index.html link to launch the software. Proceed to step 7.

7) Log in to AquaControl software. Enter your username and password and press the Log In button. If this is the first log-in to a new unit, use the factory default credentials, User ID: **admin**; Password: **secret**

5.2 OSX

1) From the desktop, click <Go>, then click on <Network>. The list of all Network devices will start populating. Wait for the list to complete.

2) Find your AquaControl device in the network device list. The device's MAC address is added to the end of it's name. The MAC address is printed on a sticker attached to the back or side panel. Double-click on the mXa device name.

3) Double click on the resulting <AquaControl> icon.

4) Double-click on the resulting <index.html> file to launch the software.

5) Log in to AquaControl software. Enter your username and password and press the Log In button. If this is the first log-in to a new unit, use the factory default credentials, User ID: **admin**; Password: **secret**

5.3 iOS

1) Use a network device discovery app such as "Flame®" to see all available network devices.

2) Find the AquaControl device in the list. Its MAC address gets added to the end of its name.

(continued on next page)

(iOS, cont.)

3) Tap on the device to launch the software. Depending on the app used, additional address or type lines may need to be entered before the software will launch.

4) Log in to AquaControl software. Enter your username and password, then tap the Log In button. If this is the first log-in to a new unit, use the factory default credentials, User ID: **admin**: Password: **secret**

5.4 Android

1) Install an Android application that can discover Network Plug'n'Play devices. There are several apps that can do this. For example, "UPnP Tool" is a free discovery app available on the Google Play Store.

2) Launch the UPnP Tool or other network discovery application and it will provide a list of all Plug'n'Play devices on your network. You should see the AquaControl device listed, with its MAC address added to the end of its name.

3) Click on the (info) information icon, ("i" in a circle), to the right of the item to bring up the details of the product. Then click on the <presentationURL> link or the <IP address> link to launch AquaControl. Your default browser will launch and connect to the device. If this is the first log-in to a new unit, use the factory default credentials, User ID: **admin**: Password: **secret**

5.5 What to do if Discovery fails?

If using a wired computer network connection, and your AquaControl device does not appear on the computer's network device list, it may be necessary to disable WiFi on your computer to allow discovery. Also confirm the computer is set for automatic (DHCP) IP configuration.

table of
contents

Automatic versus Static IP: The DHCP server (router), or direct-connected computer may arbitrarily re-assign a new IP address to the device after the IP lease expires or devices are rebooted. You'll need to rediscover the AquaControl device any time its automatic IP address gets changed. To avoid future discovery steps, connect using the hostname address, (see Getting Started section), or assign a Static IP address to the device.

To assign static IP from AquaControl software: Go to [Settings>Network>Network Configuration] and select [Manual Configuration]. Save your settings and note the IP address for future use. Important: If you are using a router, a static IP address reservation for the AquaControl device must also be entered in your router's IP administration settings. Once the device has been assigned a static IP address, the address can be entered into the browser address bar to connect directly to AquaControl.

Important: You must use an IP address with the same subnet as your router and computing device. The subnet is the first three sections of the IP address. For example, 192.168.1 is the subnet section of IP address 192.168.1.100.

Tip: The easiest thing to do is use the IP address that was automatically assigned to the AquaControl device by the router/DHCP server.

6 AquaControl™ Software

The AQM1208 uses Ashly's proprietary built-in server based software for setup and control. It is not necessary to install an application onto your computer or mobile device because the program is already resident on the AQM1208 and runs on your device browser.

AquaControl Portal AQM1208 app:

For offline software configuration or to simply explore the software without browser access to a live unit, download and install the free "AquaControl Portal AQM1208" Windows app from the Ashly website. This is a full featured but virtual AQM1208 software interface. All AQM1208 settings can be configured, user profiles created, remotes set up, presets and subpresets saved. All settings can be exported as a file for import later into a live AQM1208.

Firmware Update:

On occasion, the AQM1208 may benefit from a firmware update, provided free of charge on the Ashly website. Please verify that your unit is using the latest firmware revision, then update if necessary.

Note: Performing a firmware update will not erase any existing settings or passwords.

To Update Firmware:

- 1) After completing Network Discovery ([sec. 5](#)), check the installed firmware version by going to the software Dashboard page.
- 2) Check for the latest AQM1208 firmware on the Ashly website. If a higher version is available, click the link and download the new AQM1208 [*.bin] file.

3) In the software, go to the [Settings > General Settings] page, then click the [Update] button next to the displayed firmware version.

4) Click the [+ Firmware File] then browse for the firmware file you just downloaded. Click [Install Update] to begin the update process. The update may take several minutes to complete and will confirm when finished. *Do not remove power from the unit during the update process.*

5) After the update process is complete, reboot the unit by removing and restoring AC power.

Launch the software and login to your AQM1208. The default login credentials are:

User ID: "admin" Password: "secret"

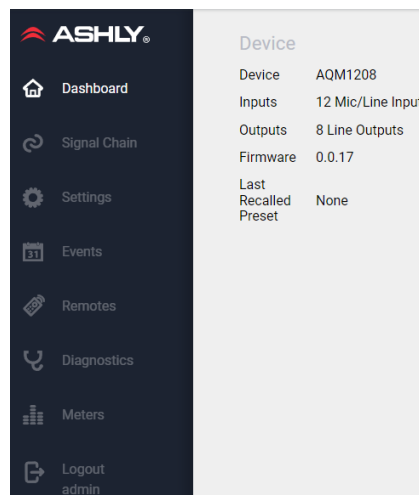

ASHLY	
Device	AQM1208
Inputs	12 Mic/Line Inputs
Outputs	8 Line Outputs
Firmware	0.0.17
Last Recalled Preset	None

6.1 Dashboard

The AQM1208 dashboard screen is the home page after launching the software. All configuration menus are found here, as well as device & firmware information, plus the last recalled preset. Menus include the following:

- Signal Chain - All DSP blocks, routing, presets, templates, mixers, and ducking.

- Settings - General settings, front & rear panel configuration and features, VCA inputs, trigger inputs, GPO logic, network, and security/user profile setup.
- Events - Scheduled and triggered events are created and managed here.
- Remotes - Remote mixers, DCA groups, and custom virtual WR5 button remotes are created and managed here.
- Diagnostics - Used for troubleshooting.
- Meters - Input, mixer input, and output meters are displayed here.
- Logout Admin - Logs out of AquaControl. Shows the current user account name when logged in.

6.1a Launch Quick Setup



Welcome to Ashly AquaControl™ software. You can use Quick Setup to easily get up and running.

Launch Quick Setup

Launch the Quick Setup and run the wizards to quickly:

- Create a new user account (see also Settings>Security)
- Set up the network (see also Settings>Network)
- Set up scheduled or triggered events (see also Events)

6.2 Signal Chain

DSP blocks are placed and configured here. Inputs 1-12 can be routed to any of eight mixers. Any mixer can be routed to any output. Every channel has a ******* icon tool used to save or load a DSP template, clear or copy a DSP chain, or add mute or output mixer connection to a subpreset. Most DSP functions can be linked across channels using one of 16 link groups. The main Editor and Diagram views are shown below:

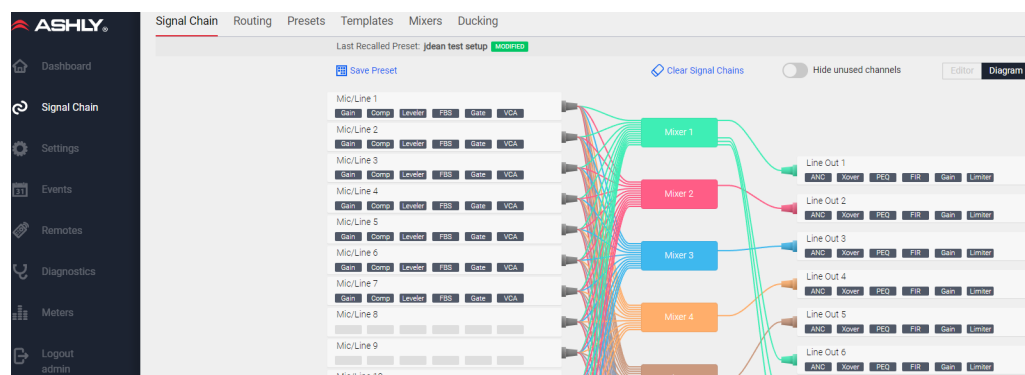
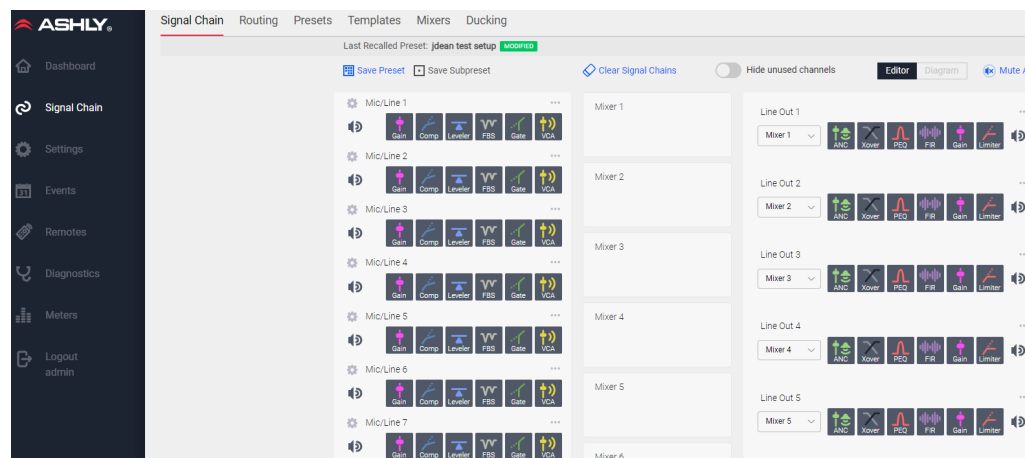

6.2a Mic/Line Inputs 1-12

- Mute/unmute channel. Place up to six DSP blocks. Click the at the upper left corner of an input channel to configure its gain or phantom power. GAIN & PHANTOM POWER SETTINGS ARE NOT STORED IN PRESETS. Click the ******* icon at the input channel's upper right corner for additional copy/subpreset/template functions. See also [Settings>Panels>Rear Panel](#).

[table of contents](#)

6.2b Mixers 1-8

- Edit mixer routing, mixer mute, fader level, ducker, automix, show/hide chains, add to sub-preset

6.2c Line Outputs 1-8

- Per output: Mixer 1-8 source select, up to six DSP blocks, mute. Click the ******* icon in the output channel's upper right corner for additional copy/paste chain utility, subpreset options, and save/load template function.

6.2d Presets, Subpresets, & Templates

Presets and **Sub-Presets** get saved to the AQM1208 for device, scheduled, or triggered recall. Use sub-presets when faster recall of a subset of parameters is desired. Before saving a sub-preset, first select the desired DSP functions and select <Add to Subpreset> for each.

Note: Recalling a Subpreset will temporarily overwrite Preset settings. When the original preset is recalled, the subpreset settings are canceled.

Templates are files that represent all the settings for a single *channel*. Using templates allows DSP settings for common signal types (such as mics, playback sources, loudspeakers) to be saved for repeated use.

6.2e DSP Blocks INPUTS OUTPUTS

DSP Block	INPUTS	OUTPUTS
Ambient Noise Comp.	-	●
Autoleveler	●	●
Brick Wall Limiter	-	●
Compressor	●	●
Crossover	-	●
DCA Gain	●	●
Delay	●	●
Feedback Suppressor	●	-
FIR Filter	-	●
Gain	●	●
Gate	●	●
High Pass Filter	●	●
Low Pass Filter	●	●
Parametric Equalizer	●	●
Signal Generator	●	●
VCA Gain	●	●

DSP Blocks Autoleveler

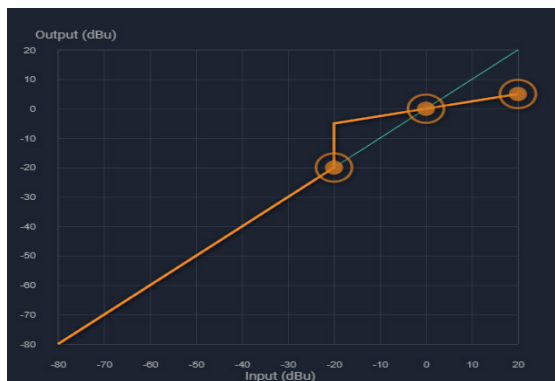

The auto leveler is a dynamics processor used to automatically boost or cut a signal to maintain a user-defined target level.

The target level is the primary setting in the autoleveler, as it determines the constant level to which an input is boost or cut.

The autoleveler can be used in situations such as speech reinforcement, where an unknown source level needs to be maintained at a specific output level. For example, a podium microphone where different speakers will be presenting may have an auto-leveler applied to ensure that strong or soft speakers' voices are presented at similar output levels.

The controls for the auto leveler are split into two categories, basic and advanced. It is recommended you start with the basic controls, and if fine tuning is required, use the advanced controls.

Warning: Depending on the settings, it is possible to apply up to 27dB of gain with the auto leveler.

Basic Parameters:

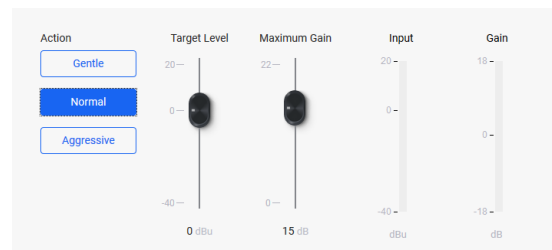

Target Level - This is the desired continuous output level of the signal.

Action - Sets the ratio, hold time, and gain change rates (see table for definitions). These settings are general starting points for how the auto leveler should behave. Action can also be user defined under advanced controls, with three drag points available for a more visual adjustment.

Action	Ratio	Hold Time	Gain Increase	Gain Decrease
Aggressive	10:1	5 Seconds	20 ms/dB	5 ms/dB
Normal	4:1	1 Second	50 ms/dB	10 ms/dB
Gentle	2:1	2 Seconds	100 ms/dB	20 ms/dB

Maximum Gain - This is the total amount of gain the auto leveler may apply before it stops affecting the signal. Maximum gain controls the threshold below target using the following formula:

$$\text{Threshold Below Target} = \text{Max Gain} \div ((1 \div \text{ratio}) - 1)$$

Advanced parameters:

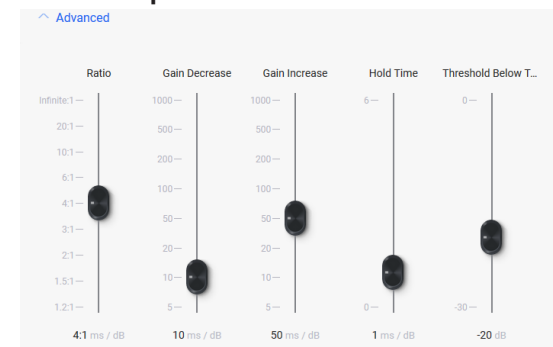

Ratio - This is the ratio of the input level change in dB to output level change in dB. It determines the degree of boost or cut applied to a signal to maintain the target level. The higher the ratio, the closer the signal above threshold will approach the target level. However, a higher level also increases how aggressive the autoleveler maintains that gain.

Threshold Below Target - Determines the relative input signal level above which the autoleveler increases gain, below which no action is taken.

Gain Decrease/Increase - Prevents sudden, choppy-sounding level changes to an input signal having a wide dynamic range.

Hold Time - This is the time after the input signal falls below the threshold, during which the autoleveler's gain is held constant before it returns to unity gain. Hold time is used in conjunction with the gain increase/decrease controls to arrive at a natural-sounding auto leveler action.

Both the standard and advanced views provide input level and gain LED meter bars. The gain bar shows the current input signal increase or attenuation as applied by the auto leveler.

Brick Wall Limiter

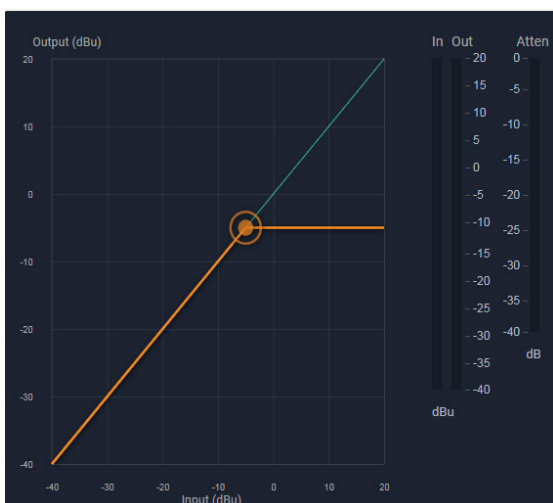

The brick wall limiter is a compressor with a fixed infinite ratio. Use this limiter to prevent signal from exceeding a designated peak level. The limiter has threshold, attack time and release time adjustments.

For a more natural sounding gain reduction that allows some signal above threshold, use the compressor function.

Parameters:

Threshold - The signal level at which the limiter begins to apply gain reduction to the signal. Threshold range is -20dBu to +20dBu.

Ratio - There is no ratio control, ratio is fixed at infinite. Signal cannot exceed the threshold.

Attack Time - The rate in mS/dB that gain reduction occurs after the signal level crosses threshold.

Release Time - The rate in mS/dB that gain reduction recovers after the signal level drops back below threshold.

Detector Type - The detector type for the brick wall limiter is set to peak detect only.

Compressor

The compressor function offers adjustable threshold, ratio, attack time, release time, plus selection of either peak or average detector.

Up to four attenuation bus assignments are available, allowing for multiple compressor blocks to track together, ie for stereo signals.

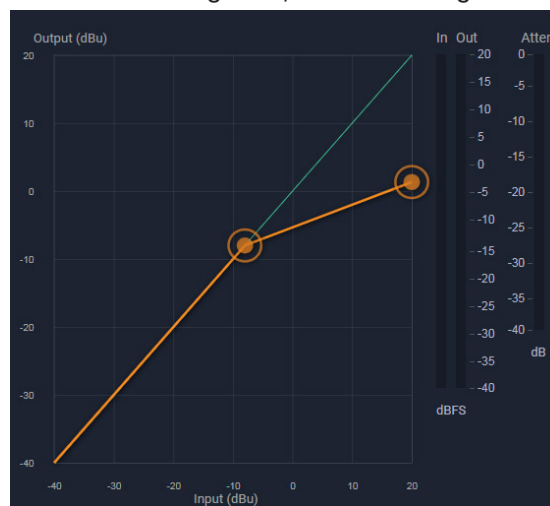

Parameters:



Detector Type - This selects between peak or average detector operation:

- **Peak Detector** - Setting the detector type to "peak" means that only the peak level of a signal is used to trigger the compressor. Peak detect is typically used for limiter applications where any signal level above a certain point is undesirable.
- **Average Detector** - Setting the detector type to average means that a computed average signal level is used instead of peak levels. The averaging detector is more musical and natural sounding and typically used to "thicken" vocals.

Attenuation Bus 1-4 - All compressors assigned to the same attenuation bus will apply the largest amount of gain reduction from any one of the assigned compressors. This is typically used for tracking compression across stereo signals.

Threshold - The signal level at which the compressor begins to apply gain reduction to the signal. Threshold range is -20dBu to +20dBu.

(continued on next page)

(compressor, cont.)

Ratio - The amount of gain reduction applied to signal exceeding threshold. Range is 1.2:1 to infinite.

Attack Time - The rate in mS/dB that gain reduction occurs after the signal level crosses threshold.

Release Time - The rate in mS/dB that gain reduction recovers after the signal level drops back below threshold.

DCA Gain



A DCA gain block can be placed on any channel to make that channel available for control within DCA groups 1-4.

Individual DCA blocks must be turned ON to be active, then each DCA block must be enabled for its targeted DCA group.

The level control first sets the channel's level to the DCA, then that gets combined with any enabled DCA 1-4 fader group levels.

A DCA group is typically set up and deployed to a remote operator who has limited access but still needs to control a zone's overall volume via mobile device or tablet. See [section 7](#) for deploying a DCA to a remote control operator.

table of contents

DCA Gain Parameters:

Overall Level to DCA: Off, -50dB to +12dB

DCA Input Polarity: Normal, Inverted

DCA 1-4 Level: -50dB to +12dB, Mute

DCA 1-4 Enable: On, Off

Delay



Delay can be used on any input or output channel, with a delay range of 0-682ms. Delay can be input by time (ms) or by distance (ft, m), using the scroll bar or by manually entering a numeric value. Ambient air temperature can be entered to adjust for changes to the speed of sound through hotter or colder air.

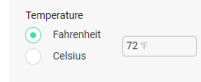

Feedback Suppressor (FBS)

The FBS function is available on inputs 1-8 only. Once placed in an input DSP signal chain, use its master On/Off button to engage the FBS function. Once engaged, the FBS becomes active and automatically adjust up to 12 filters as needed to eliminate detected feedback.

The feedback suppressor intelligently uses notch filters and parametric filters to suppress multiple feedback tones, while maintaining a pleasing sound with either music or speech content.

The default FBS behaves automatically once enabled, but each of 12 filters can also be individually enabled/disabled, locked/unlocked, or configured using one of the following types of filter modes:

- **Restricted** filter - The restricted filter's automated attenuation level can only be made deeper, or filter bandwidth made broader. This mode might typically be used in a fixed install where microphones and speakers never move.
- **Floating** filter - This is the default setting. A floating filter's parameters are dynamic, in that the feedback detector slowly removes a floating filter if it is no longer needed, it then becomes available to re-deploy at a different frequency. This mode would typically be used in a dynamic environment where input sources, microphone placement, and speaker locations routinely change.
- **Float time** is the time allowed to pass after which the detector will remove the filter. *Only floating filters are affected by the float time parameter.*
- **Manual** - In this mode, the filter is not automatically controlled, it can only be controlled manually by the user.

The FBS will automatically try to use restricted filters first if there is one already deployed close to the feedback frequency. If there are no more restricted filters near the detected feedback, the FBS will use enabled floating filters. The FBS algorithm will not change manual filters.

(continued on next page)

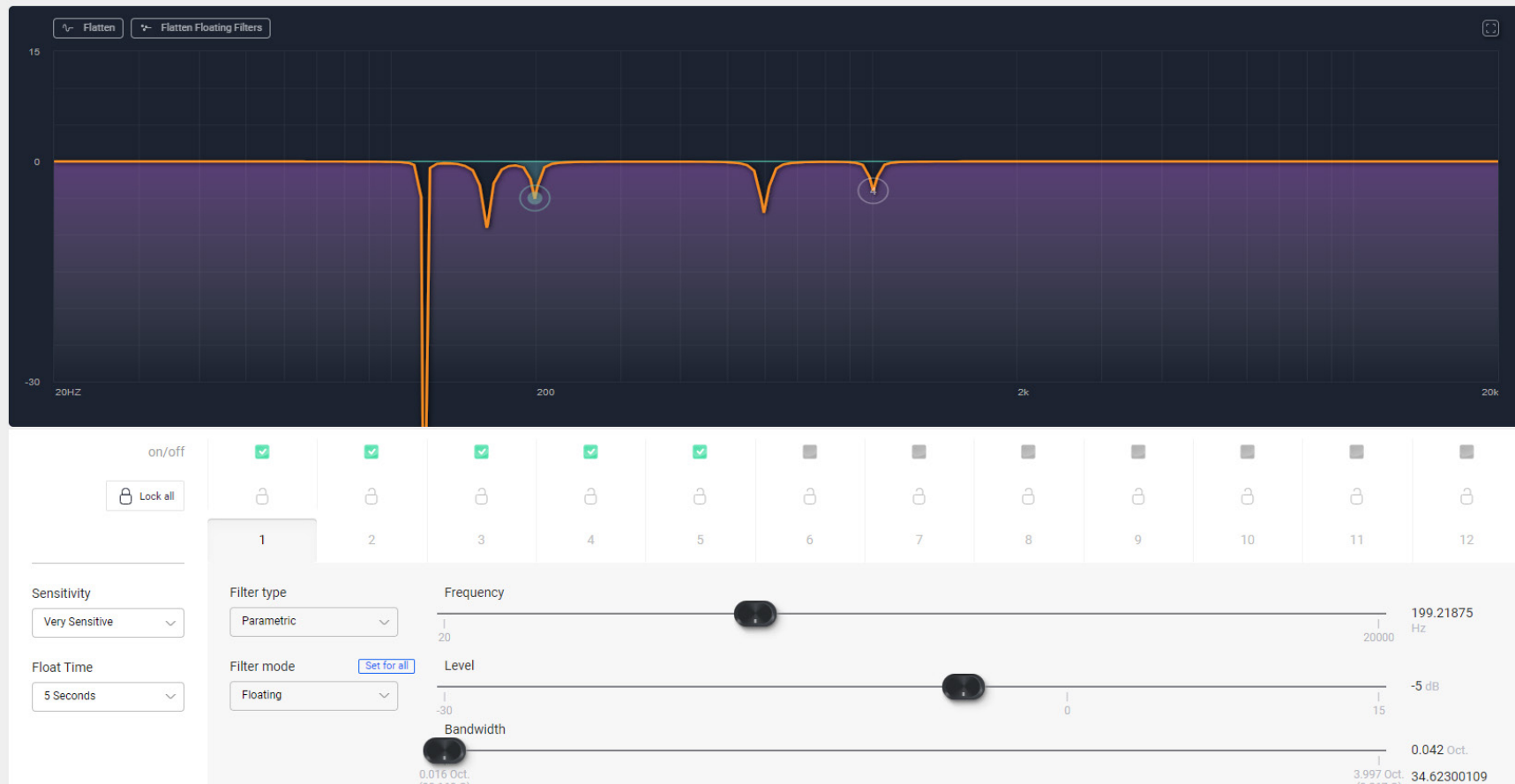

The **Sensitivity** control has five levels. This adjusts how sensitive the FBS algorithm is to detecting feedback and inserting filters. For example, a setting of <Very Sensitive> means the algorithm will aggressively look for anything that could be feedback and hence, may insert filters on sustained musical tones.

A setting of <Very Insensitive> means that the FBS would only insert a filter in the presence of a prolonged feedback tone with very little background noise.

The optimal setting of the sensitivity control depends on both the spectral content of the audio program (how much the musical instruments sound like feedback), and on the amount of background music and noise which tends to mask feedback from the detector. It is best to start with an average sensitivity setting and experiment.

A locked filter  is prevented from being changed in any way, either automatically by the FBS, or manually by the user. To change or reset a filter, it must first be unlocked.

Gain

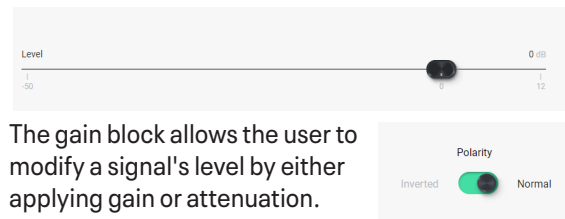

The gain block allows the user to modify a signal's level by either applying gain or attenuation. The polarity of the signal may also be inverted. The level control allows for gain adjustment between +12dB and -50dB and OFF. The level fader can be adjusted in 0.1 dB increments. *Note: A gain control must be placed if using a gain increment/decrement event ([sec 6.4](#)).*

Gain Parameters:

Level: Off, -50dB to +12dB in 0.1 dB increments

Polarity: Normal or inverted

Gate (Noise Gate)

A noise gate can be used to minimize unwanted, low level ambient sounds from getting through on an individual input channel. Threshold is the level above which an input signal will pass through, below which its signal is attenuated by the range value. Attack and release controls set the time characteristics of the gating action. Attack sets the amount of time used to ramp up the gain to unity. Release sets the time required to attenuate the signal. The gate may be assigned to a link group to link its parameters with other channel gates.

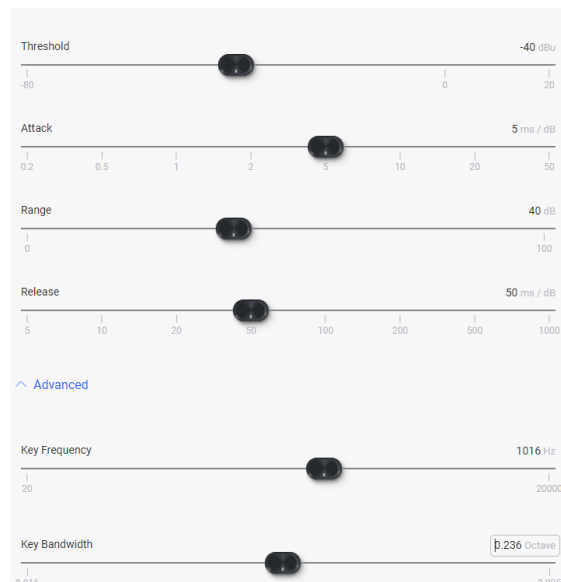

Gate Parameters:

Threshold: The minimum input signal level (also called key signal) required to open the noise gate and allow signal to pass through. Threshold can be set using the slide fader, text entry box, or a drag point on the graph.

Attack: The rate at which input signal level rises up to unity gain after reaching the gate threshold.

Range: The amount of attenuation applied to the gated signal when it remains below threshold, sometimes referred to as "floor".

Release: The rate at which attenuation is applied to the signal after it falls back below gate threshold.

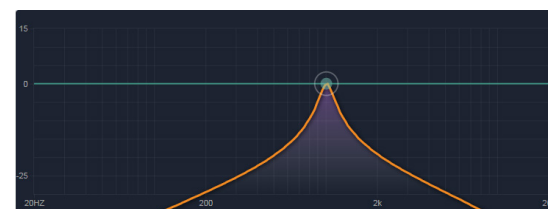

Advanced Mode Parameters:

Advanced mode allows the user to employ a key filter for the gate. A key filter does not EQ the signal passing through the gate, but rather allows the gate threshold detector to respond only to a frequency band (pass-band) within the signal as determined by the filter. The key filter is a band-pass filter with selectable center frequency and bandwidth.

Key Frequency: This is the center frequency of the key filter.

Key Bandwidth: This sets the bandwidth used for the key filter, and is always on. The default bandwidth setting is a very wide 15 octaves, and as such has no frequency-specific effect.

To use frequency selective key threshold detection, adjust the key bandwidth to a lower setting and set the frequency and bandwidth as desired.

High-Pass Filter

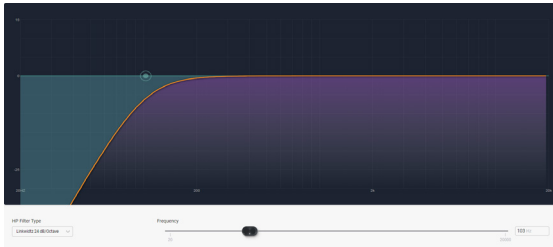

A high-pass filter (HPF) is a single ended filter without a level control, passing only signal above the selected corner frequency. Filter types include Bessel, Butterworth, Linkwitz, and Linkwitz Notch, offering a variety of filter slope values.

HPF Parameters: filter type, frequency

Low-Pass Filter

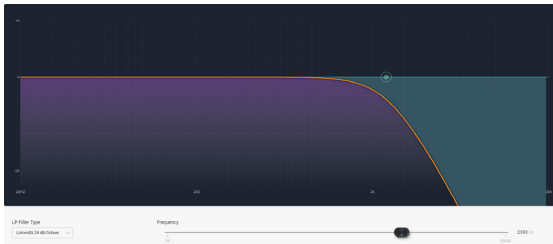

A low-pass filter (LPF) is a single ended filter without a level control, passing only signal below the selected corner frequency. Filter types include Bessel, Butterworth, Linkwitz, and Linkwitz Notch, offering a variety of filter slope values.

LPF Parameters: filter type, frequency

Parametric Equalizer

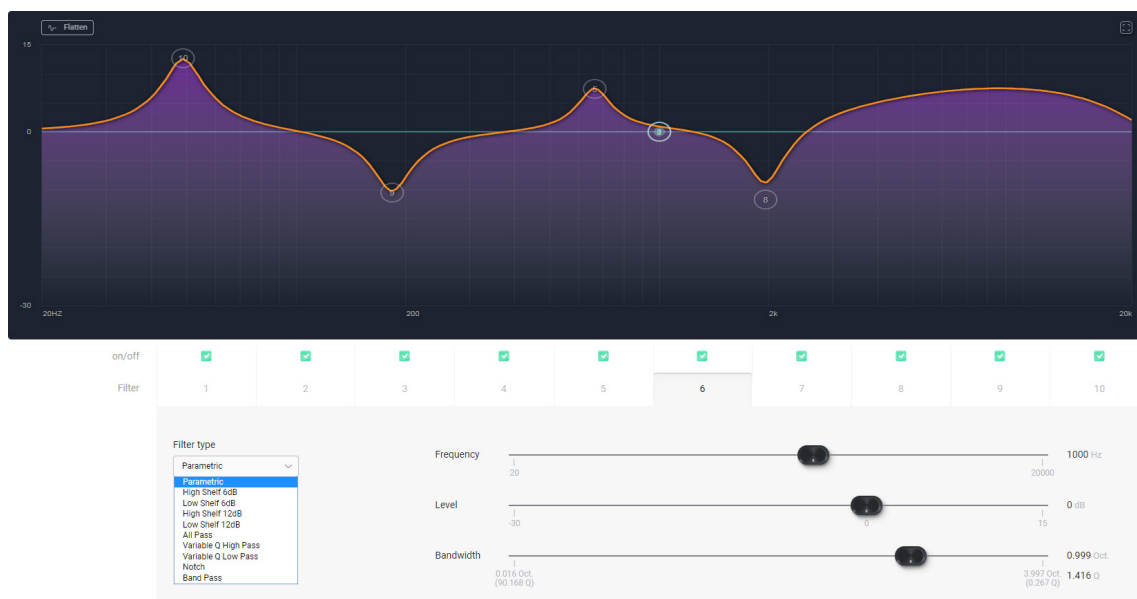

The PEQ parametric equalizer offers a variety of useful filter types for adjusting signal response with greater precision. A master on/off button enables/disables the PEQ block.

10 individual filters are available per PEQ block, each filter capable of the following types: Parametric, high-shelf and low-shelf at 6dB/octave or 12dB/octave, all-pass, variable-Q high-pass and low-pass, notch, and band-pass. Each individual filter has an on/off button.

Select a filter number first, then choose a filter type, then adjust by dragging its control node, using the slide-controls, or by entering parameter values in the text boxes to the right of each control.

PEQ Parameters:

Filter 1-10: filter On/Off, active selection

Filter Types:

- **Parametric:** Symmetric boost/cut, allowing individual adjustment of center frequency, level and bandwidth.
- **High-Shelf:** Asymmetric boost or cut with "shelving" shape. Allows adjustment of the corner frequency and amplitude. Slope can be selected as 6 dB/octave or 12 dB/octave.
- **Low-Shelf:** Mirror-image of high-shelf.
- **All Pass:** Provides no change in amplitude, but adds -180° phase shift at the corner frequency.
- **Variable Q HPF:** Second order high pass filter with adjustable Q.

- **Variable Q LPF:** Second order low pass filter with adjustable Q.
- **Notch:** Infinite cut at specified center frequency, with adjustable bandwidth or Q.
- **Band Pass:** This will pass signals within the filter's response region. It allows adjustment of center frequency and bandwidth/Q. Gain is 0 dB at the center frequency.

Frequency: Selected filter center/corner frequency.

Level: Selected filter boost/cut amplitude. Some filter types do not offer level control.

Bandwidth: Selected filter bandwidth (or Q). Some filter types do not offer bandwidth control.

Filter Type Details

Parametric EQ Filters

Parametric EQ uses peak filters with the ability to control boost or cut, frequency center, and bandwidth. Think of one band of parametric EQ as a single graphic equalizer fader, except that the frequency is variable, and the bandwidth, or how "wide" the filter affects the frequency spectrum at the center frequency, is also variable. The smaller the bandwidth, the less the audio signal on either side of the frequency center is boost or cut, whereas a larger "wider" bandwidth produces an audible change to the overall tone of a signal.

Parametric filters are best used to hunt down and eliminate problem feedback frequencies, add or remove a characteristic "hot spot" from microphones, or clean up room resonance situations. It is well worth the time becoming proficient with parametric EQ filters, as they offer the best solution to many EQ problems.

(continued on next page)

(parametric EQ, cont.)

Parametric filters have a boost/cut range of +15dB to -30dB. There is more cut than boost because one of the more common uses for parametric filters is to dramatically cut, or "notch out", very narrow frequencies (low bandwidth) in order to eliminate system feedback problems.

Each of the 10 parametric filters has an adjustable center frequency. An individual filter's frequency can be dragged and set from 20Hz to 20kHz, and can also be manually typed into the text box. Carefully sweeping a narrow bandwidth filter through a problem feedback area, with just a slight boost in level, is a quick way to find the exact frequency causing trouble. Once the offensive frequency has been found, cut the filter's level, and then adjust the bandwidth as narrow as possible while still eliminating the feedback problem.

Bandwidth is adjustable from about 1/64 octave to four octaves, and the lower the bandwidth, the less audible the filter action will be. Finding the problem frequency is relatively easy, but finding the best combination of cut and bandwidth takes a little practice. Again it is well worth the time getting comfortable with the notching procedure, so that problems can be quickly addressed with a sufficient but minimal amount of correction.

Shelving EQ Filters

1st order filters use a gentle 6dB per octave slope, while 2nd order filters use a 12dB per octave slope for a more pronounced boost or cut. All shelving filters have a boost/cut range of +/- 15dB and frequency range from 20Hz through 20kHz. Shelving filters are most useful as broad tone controls to boost or cut the high

end or low end of an audio signal's frequency content. Because they affect a wider spectrum of audio, they are not as suitable for feedback control as parametric filters.

All-Pass Filters

The all-pass option is a 2nd order all-pass filter which provides a -180° phase shift at the corner frequency. At very high frequencies the phase delay approaches -360°. All-pass filters may be used to add frequency dependent phase shift or phase delay to the audio signal path. It does not produce a measurable effect on the magnitude response of the signal.



Signal Generator

The signal generator creates pink noise, white noise or a sine wave output.

When a signal generator is placed in an input signal chain and turned on, audio input for that channel becomes disabled.

When placed in an output signal chain and turned on, the mixer signal routed to that output becomes disabled.

White noise is randomly generated broadband noise.

Pink noise is bandwidth-limited from 20Hz - 20kHz to contain equal energy in any octave (-6 dB per octave low-pass filtered).

The sine wave has adjustable frequency. All three signal types can be generated at any level from -50dBu to +20dBu.

Signal Generator Parameters

Signal Type: Pink noise, white noise, or sine wave

Frequency: Frequency of signal to be generated (sine wave only).

Level: RMS level of signal generated.

Bypass: Turns off generated signal and allows audio signal to pass through.

VCA Gain

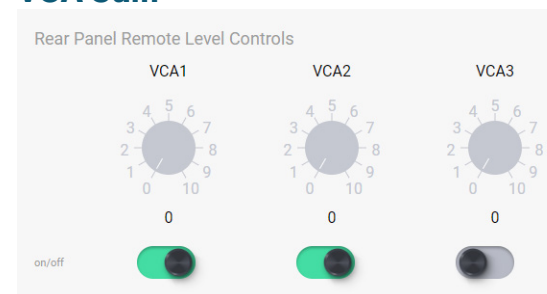

Eight back-panel VCA (voltage controlled amplifier) input pins are used to remotely control the level of assigned inputs or outputs using a simple potentiometer circuit.

In order to use VCA inputs, one or more VCA gain blocks must first be placed in a signal chain, then assigned to VCA inputs 1-8. A single VCA input on the back panel can be used to control multiple VCA Gain blocks.

VCA gain blocks can be individually turned On/Off. They are saved in a preset or sub-preset.

Use an Ashly [WR-1](#) remote or equivalent to send a variable DC voltage to a VCA input.

The current position of any connected potentiometer is shown in software in the Settings>Panels>Rear Panel screen.

See sec. [4.5](#) or [7.2a](#) for more details.

Ambient Noise Compensation - ANC (output channels only)

Signal Chain > Line Out 1 - Ambient Noise Compensation On Link group

Ambient noise compensation (ANC) is an automatic output level control that uses a microphone monitoring a zone's ambient background noise to adjust overall output level for that zone, automatically maintaining intelligibility above the ambient noise.

Note: The ambient sensing microphone input can not be routed to the zone's mixer.

The ambient noise sensing mic is processed similar to a slow-responding SPL meter, which is then used as the control signal for the automatic level control of the program audio.

The ambient sensing microphone doesn't need to be a high-quality microphone. It is only used to detect the overall noise level in the zone and is not used for the direct program audio or paging.

The placement location of the noise-detecting microphone is very important for the ambient noise compensation function to work well. A unidirectional microphone pointed toward

the noise sources *but away from any speakers* works best.

ANC Parameters:

Max Gain: This sets the maximum gain the ANC can apply to the program audio. A typical starting value is 10 dB.

Min Gain: This sets the base level of the program audio before any ANC action affects it. When the noise detecting mic exceeds the noise threshold, ANC applies gain above the minimum gain setting according to the Program/Ambient Gain Ratio setting. A typical starting value for minimum gain is -20 dB.

Gain Change Rate: This is the rate at which the ANC will increase the gain, measured in seconds per dB. A typical starting value is 2 seconds/dB.

Input Level Meter: This indicates the level of the program audio *before* any ANC gain or attenuation is applied.

ANC Gain Meter: This shows the current gain or attenuation being applied to the program audio by the ANC function.

ANC Mixer Input Channel: This selects the mic input channel used for ambient noise sensing. The mic signal is taken post-input DSP. *The mic must not be routed to the ANC zone.*

Noise Threshold: This sets the ambient noise mic level above which the ANC will begin increasing the program audio gain above the minimum gain setting. A typical starting value is -30 dBu. Keep in mind that any changes to the noise-sensing microphone gain will affect the action of the noise threshold control.

Program/Ambient Gain Ratio: This sets the ratio of dB increase in program level for every 1 dB increase in ambient noise level. A typical starting value is 1.0 which means that for every 1 dB increase in ambient noise above the threshold, the ANC will increase the gain of the program audio by 1 dB.

(continued on next page)

(ambient noise compensation, cont.)

Average Noise Meter: This meter indicates the averaged level of the ambient noise sensing microphone.

ANC Setup Procedure

- In software, place an ANC block on the output channel to be used for background music or voice paging in that zone.
- Open the ANC block to edit its control window. Set the ANC controls to the typical settings described above, which are the default settings of a new ANC block when it is first placed.
- Turn the ANC function ON.
- Select the noise-sensing microphone input from the drop-down box labeled "Mixer Input Channel". Make sure the mic is not routed to the output channel using ANC.
- Physically locate the noise-sensing microphone in the zone by pointing it toward the primary noise sources such as groups of people, HVAC equipment, vehicle traffic etc, but pointed away from the sound system speakers or their direct reflections.
- Add appropriate mic preamp gain to the ambient-sensing mic channel, add gain, EQ, HPF or LPF, compression, or even a noise gate if desired. The noise-sensing microphone signal will appear on the Average Noise input level meter. To set up ANC controls for effective operation without ambient noise sources present, a pink noise source or even a portable stereo can be placed near the expected ambient noise source to simulate anticipated volumes.
- Beginning at -40dBu, adjust the Noise Threshold control to respond to the average noise input level above which point you want the program audio to begin increasing.
- Increase the zone noise source volume until you see the average noise meter rise above your noise threshold setting. You should begin to see the ANC Gain meter slowly rise above the minimum gain setting.
- Slowly increase the noise source further and adjust the program/ambient gain ratio for the desired amount of noise compensation.
- Continue to increase the noise source volume to the highest anticipated level. Adjust the max gain to a level which limits the maximum gain that the ANC applies to the program audio so it will not become too loud or clip.
- The gain change rate can be adjusted according to how fast you would like the gain increase to occur in response to increases in ambient noise.
- Be aware that an improperly setup ANC can result in runaway gain where the program audio is picked-up by the noise-sensing microphone as background noise. The result is not necessarily feedback squeals, but the gain of the program audio could ramp up to the max gain value even with no ambient room noise. The best remedy for this problem is to locate the noise-sensing microphone closer to the expected noise sources and further away from the sound system speakers or their reflections. A baffle can be constructed between the speaker and microphone to block direct or reflected sound pickup. Also, the Program/Ambient Gain Ratio can be lowered to reduce the susceptibility to gain runaway.

Crossover (output channels only)

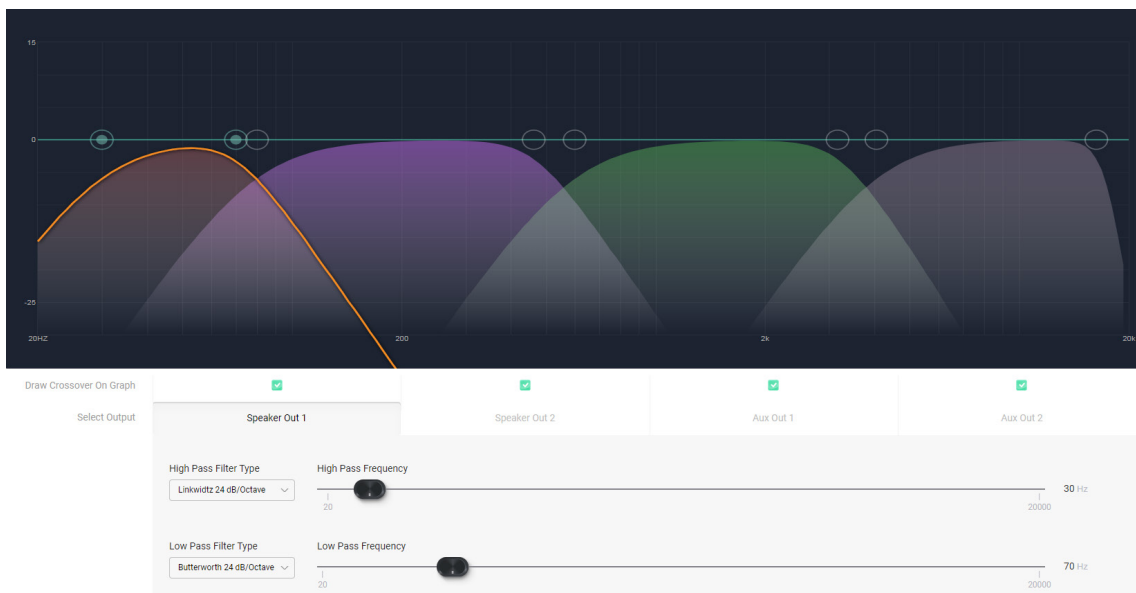

Crossover blocks can be placed on any output channel. A high-pass and low-pass filter type and frequency get applied to each crossover block to band-limit the signal for that output.

All outputs populated with a crossover block are shown combined on screen for clear visual representation of crossover settings. Select any of the four outputs to edit their filter parameters.

Filter types can be selected to match the acoustic response of your loudspeaker system. Consult the loudspeaker manufacturer for their recommended crossover filter types and frequencies.

Available Filter Types:

Butterworth: Butterworth filters have a maximally flat magnitude response and sharpest transition to the stop-band, and are available in 1st through 8th order filters (6, 12, 18, 24, 30, 36, 42, 48dB/octave).

Linkwitz: Linkwitz-Riley filters exhibit flat combined on-axis magnitude response, and are available in 2nd, 4th, 6th, and 8th order filters (12, 24, 36, 48dB/octave).

Bessel: Bessel filters have a maximally flat phase response, and are available in 2nd, 3rd, 4th, 5th, 6th, 7th, and 8th order filters (12, 18, 24, 30, 36, 42, 48dB/octave).

Linkwitz Notch: Linkwitz-Notch filters exhibit fast rolloff with ripple in the stopband, and have flat combined on-axis magnitude response. They are available as 4th and 8th order (24, 48dB/octave).

Filter Type	Order	Combined Response at Crossover Frequency (dB)	Polarity
Butterworth	1st	0.0	normal
	2nd	3.0	<i>*inverted</i>
	3rd	0.0	normal
	4th	3.0	normal
	5th	0.0	normal
	6th	3.0	<i>*inverted</i>
	7th	0.0	normal
	8th	3.0	normal
Linkwitz	2nd	0.0	<i>*inverted</i>
	4th	0.0	normal
	6th	0.0	<i>*inverted</i>
	8th	0.0	normal
Bessel	2nd	2.7	<i>*inverted</i>
	3rd	2.9	<i>*inverted</i>
	4th	1.7	<i>*inverted</i>
	5th	1.1	normal
	6th	2.2	normal
	7th	2.9	normal
	8th	3.0	normal
	Linkwitz Notch	4th	0.0
8th		0.0	normal

**Inverted outputs may require polarity change using gain block to prevent undesired notch at crossover point.*

FIR Filter (output channels only)

A FIR (finite impulse response) filter is typically used when a speaker manufacturer develops and provides a proprietary FIR coefficient file that corresponds directly to their own loudspeaker or speaker cabinet, addressing frequency and phase issues based on their own measurements and formulations.

Sample Rate	48 kHz
Number of Taps	0
Filename Loaded	FIR source filename not available

+ Add FIR File or drag and drop file here

Plugging in a FIR filter DSP block then clicking on it will prompt the user for a *.fir, *.txt, or *.csv text file, which is then loaded and applied to the output DSP. The two file types have identical coefficient code, however the *.fir or *.txt file may add comments (designated by a semi-colon) or a key=value pair definition such as sample rate. Both file types will work in AquaControl.

The DSP sample rate is always 48kHz.

FIR filters on this device can have from 2 up to 512 taps.

AquaControl software does not offer the ability to view or edit the EQ curve or phase response generated by a FIR filter.

*.fir or *.txt file example:

```
; comments section *
sampleRate = 48000 *
+0.0000042920
+0.0000030236
-0.0000040482
-0.0000040236
```

**The comments section and key=value pair definition (in this example sample rate) are not necessary in a *.fir or *.txt file. AquaControl ignores text headers and only uses the actual coefficient values, which can be either line separated or comma separated.*

*.csv file example:

```
+0.0000042920, +0.0000030236, -0.0000040482, -0.0000040236
```

6.2h Signal Chain > Mixers 1-8

All input channels can be independently routed and mixed to all eight mixers. The eight output channels can then use any one of the eight mixers as their source. If desired, the same mixer can be used on multiple output channels.

Each mixer provides mixer 1-8 select, input channel level faders, pre-fader input level LEDs, mixer mute, route enable per channel, automix enable on inputs 1-8 only, automix response time, and ducker On/Off for that mixer.

Automixer

The automixer is used to automate the mixing of multiple speech microphones to follow the dynamic nature of the speech dialog and attenuate idle microphones. The automixer may also be used in conjunction with the autoleveler, compressor, feedback suppressor, or gate on the input signal paths. This gives the user advanced control of varied input signal levels produced by different voices.

Ashly Auto Mixer Technology

The automixer function is a "gain-sharing" type which automatically makes smooth gain transitions on all automixer input channels to achieve a constant total system gain. This gain-sharing method of automixing has been found to be superior to gating automixers due to the following characteristics:

(continued on next page)

(*auto-mixer, cont.*)

- The automatic gain action has a smooth transparent sound as though a person were mixing the inputs to follow the audio program rather than rapid gating on-and-off of channels.
- Properly designed gain-sharing automixers correctly adjust for mixing of coherent versus non-coherent signals for a more consistent final mix level without feedback as channel gains are automatically changing.
- A gain-sharing automixer is easier to setup and adjust without the need for threshold, attack, release, depth, and number-of-open-mics (NOM) controls.

Mixer input channels can be individually selected as auto-mixed or manual mixed, all summed together to the same mixer output. Channels which are selected as auto will participate in the automix in that they will contribute to the automatic adjustment of other automix channel gains. Likewise, their channel gain will be affected by the signal level present on other automix channels. Manual mixer channels (not selected as auto) will mix independently of the automixer channels into the output, only controlled by their fader setting. The fader on auto channels still controls the input level before automatic mixing takes place so that more of the system gain can be applied to one channel versus another.

Automixer Setup

Setting-up the Ashly gain-sharing automixer is quite simple compared to other gating-type automixers. The following procedure is recommended for most multi-microphone speech applications.

- Start with all mixer faders off and the automixer response time set to 0.1 seconds.
- Configure the mixer's input channel routing as desired, then select <Automix> on the mixer channels to be automixed.
- Start with one of the main speech channels, or one which is centrally located. Slowly increase the fader for this one channel just until feedback starts, then lower the fader approximately 3 dB to stay comfortably below feedback. This sets the total mixer system gain.
- Now increase the level of the other automix-enabled input channels to approximately the same position as the first channel. The system will not feedback because the automixer will slowly attenuate the active channels as more channels are turned-on to maintain a constant total system gain.
- During the program, individual channel faders may be raised or lowered to adjust for the weakness or strength of the respective talkers while the automixer is active.

6.2i Signal Chain > Ducking

Input	Duck Active	Name	Priority	Filibuster	Threshold	Depth	Hold	Release
1	<input checked="" type="checkbox"/>	Mic/Line 1	1	Off	-30 dBu	5 dB	0 sec	50 ms / dB
2	<input checked="" type="checkbox"/>	Mic/Line 2	2	Off	-30 dBu	5 dB	0 sec	50 ms / dB
3	<input checked="" type="checkbox"/>	Mic/Line 3	3	Off	-30 dBu	5 dB	0 sec	50 ms / dB
4	<input checked="" type="checkbox"/>	Mic/Line 4	4	Off	-30 dBu	5 dB	0 sec	50 ms / dB
5	<input checked="" type="checkbox"/>	Mic/Line 5	1	Off	-30 dBu	5 dB	0 sec	50 ms / dB
6	<input checked="" type="checkbox"/>	Mic/Line 6	1	Off	-30 dBu	5 dB	0 sec	50 ms / dB
7	<input checked="" type="checkbox"/>	Mic/Line 7	1	Off	-30 dBu	5 dB	0 sec	50 ms / dB
8	<input checked="" type="checkbox"/>	Mic/Line 8	1	Off	-30 dBu	5 dB	0 sec	50 ms / dB
9	<input checked="" type="checkbox"/>	Mic/Line 9	1	Off	-30 dBu	5 dB	0 sec	50 ms / dB
10	<input checked="" type="checkbox"/>	Mic/Line 10	1	Off	-30 dBu	5 dB	0 sec	50 ms / dB
11	<input checked="" type="checkbox"/>	Mic/Line 11	1	Off	-30 dBu	5 dB	0 sec	50 ms / dB
12	<input checked="" type="checkbox"/>	Mic/Line 12	1	Off	-30 dBu	5 dB	0 sec	50 ms / dB

This dedicated ducking setup screen is used for easy editing and at-a-glance visibility of all ducking trigger properties.

- All eight mixers (zones) have their own independent ducking with ON/OFF.
- **Priority:** Each input can be assigned a ducking priority from 1 to 12, with 1 being highest priority. Multiple channels can share the same priority level.
- **Filibuster:** An input channel set to filibuster ON, with signal present, will mute and maintain control over all other channels also set to filibuster ON, *as long as filibuster channels are all assigned the same priority*

level. Control is given up when input signal on the active filibuster channel stops.

- **Threshold:** Threshold determines the input signal level required to activate that channel's ducking control over other lower priority channels. *To prevent an input channel from ducking other channels, set its priority to 12 (the lowest), or set its trigger threshold to maximum (+20dBu).*
- **Depth:** Ducking depth is the level of reduction in signal for that channel when it is ducked by another channel with a higher priority. Ducking depth can be set from 0dB to -inf (off).

- **Hold:** The hold time sets how much time ducked signal on that channel remains ducked before releasing.
- **Release:** Release time is how long it takes that channel's ducked signal to return to its normal level, after a higher-priority channel drops below its triggering threshold. Release time also follows any hold time that has been set for that channel. Release time can be set from 2ms/dB to 1000ms/dB.

6.2j Signal Chain > Routing

ASHLY®												
Signal Chain	Routing	Presets	Templates	Mixers	Ducking							
Input	1	2	3	4	5	6	7	8	9	10	11	12
Clear Routing	Mic/Line 1	Mic/Line 2	Mic/Line 3	Mic/Line 4	Mic/Line 5	Mic/Line 6	Mic/Line 7	Mic/Line 8	Mic/Line 9	Mic/Line 10	Mic/Line 11	Mic/Line 12
Mixer 1	<input checked="" type="checkbox"/>	<input checked="" type="checkbox"/>	<input checked="" type="checkbox"/>	<input checked="" type="checkbox"/>	<input checked="" type="checkbox"/>	<input checked="" type="checkbox"/>	<input checked="" type="checkbox"/>	<input checked="" type="checkbox"/>	<input checked="" type="checkbox"/>	<input checked="" type="checkbox"/>	<input checked="" type="checkbox"/>	<input checked="" type="checkbox"/>
Mixer 2	<input checked="" type="checkbox"/>	<input checked="" type="checkbox"/>	<input type="checkbox"/>	<input type="checkbox"/>	<input type="checkbox"/>	<input type="checkbox"/>	<input type="checkbox"/>	<input type="checkbox"/>	<input checked="" type="checkbox"/>	<input checked="" type="checkbox"/>	<input type="checkbox"/>	<input type="checkbox"/>
Mixer 3	<input type="checkbox"/>	<input type="checkbox"/>	<input checked="" type="checkbox"/>	<input checked="" type="checkbox"/>	<input type="checkbox"/>	<input type="checkbox"/>	<input checked="" type="checkbox"/>	<input checked="" type="checkbox"/>	<input type="checkbox"/>	<input type="checkbox"/>	<input type="checkbox"/>	<input type="checkbox"/>
Mixer 4	<input type="checkbox"/>	<input type="checkbox"/>	<input type="checkbox"/>	<input type="checkbox"/>	<input checked="" type="checkbox"/>	<input checked="" type="checkbox"/>	<input type="checkbox"/>	<input type="checkbox"/>	<input type="checkbox"/>	<input type="checkbox"/>	<input type="checkbox"/>	<input type="checkbox"/>
Mixer 5	<input type="checkbox"/>	<input type="checkbox"/>	<input type="checkbox"/>	<input type="checkbox"/>	<input checked="" type="checkbox"/>	<input checked="" type="checkbox"/>	<input checked="" type="checkbox"/>	<input checked="" type="checkbox"/>	<input type="checkbox"/>	<input type="checkbox"/>	<input type="checkbox"/>	<input type="checkbox"/>
Mixer 6	<input type="checkbox"/>	<input type="checkbox"/>	<input type="checkbox"/>	<input checked="" type="checkbox"/>	<input type="checkbox"/>	<input type="checkbox"/>	<input type="checkbox"/>	<input type="checkbox"/>	<input checked="" type="checkbox"/>	<input checked="" type="checkbox"/>	<input type="checkbox"/>	<input type="checkbox"/>
Mixer 7	<input type="checkbox"/>	<input type="checkbox"/>	<input checked="" type="checkbox"/>	<input type="checkbox"/>	<input type="checkbox"/>	<input type="checkbox"/>	<input type="checkbox"/>	<input type="checkbox"/>	<input type="checkbox"/>	<input type="checkbox"/>	<input checked="" type="checkbox"/>	<input checked="" type="checkbox"/>
Mixer 8	<input checked="" type="checkbox"/>	<input checked="" type="checkbox"/>	<input type="checkbox"/>	<input type="checkbox"/>	<input type="checkbox"/>	<input type="checkbox"/>	<input type="checkbox"/>	<input type="checkbox"/>	<input type="checkbox"/>	<input type="checkbox"/>	<input type="checkbox"/>	<input type="checkbox"/>

Output	Name	Source
1	Line Out 1	Mixer 1
2	Line Out 2	Mixer 2
3	Line Out 3	Mixer 3
4	Line Out 4	Mixer 1
5	Line Out 5	Mixer 1
6	Line Out 6	Mixer 6
7	Line Out 7	Mixer 7
8	Line Out 8	Mixer 8

The signal chain routing screen allows fast setup and review of all mixer input routing, as well as assignment of output channel source selection.

6.3 Settings

The settings screens are where general settings, panel settings, network settings, security settings, and user profiles are configured.

6.3a Settings > General Settings

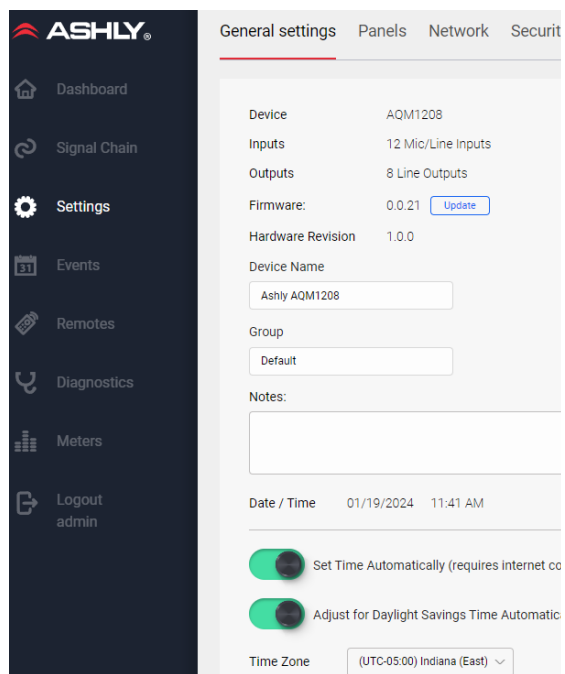

This screen displays the current device, its firmware & hardware revision, a button to update the firmware (see section 6), editable device and group names, and configuration of the Real Time Clock. The real time clock is used for scheduled events.

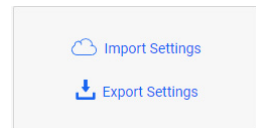

This page is also where to **import/export all settings** on your AQM1 208.

To export the *.bin file to your browser's download folder, click "Export", then click "Keep", for Windows security to allow the action.

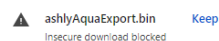
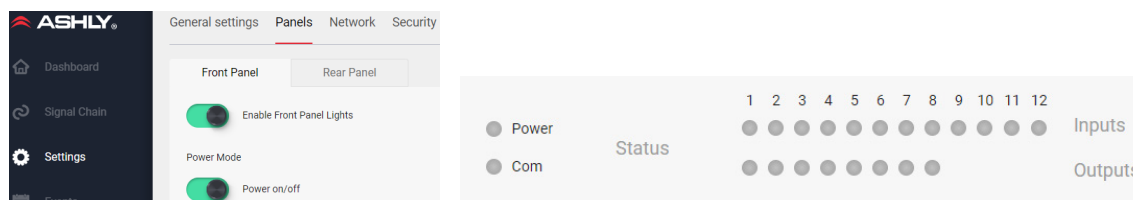

table of contents

6.3b Settings > Panels > Front Panel



- Enable Front Panel Lights: On/Off
- Enable Power: On/Off
- Front Panel LEDs: current status

6.3d Settings > Panels > Rear Panel

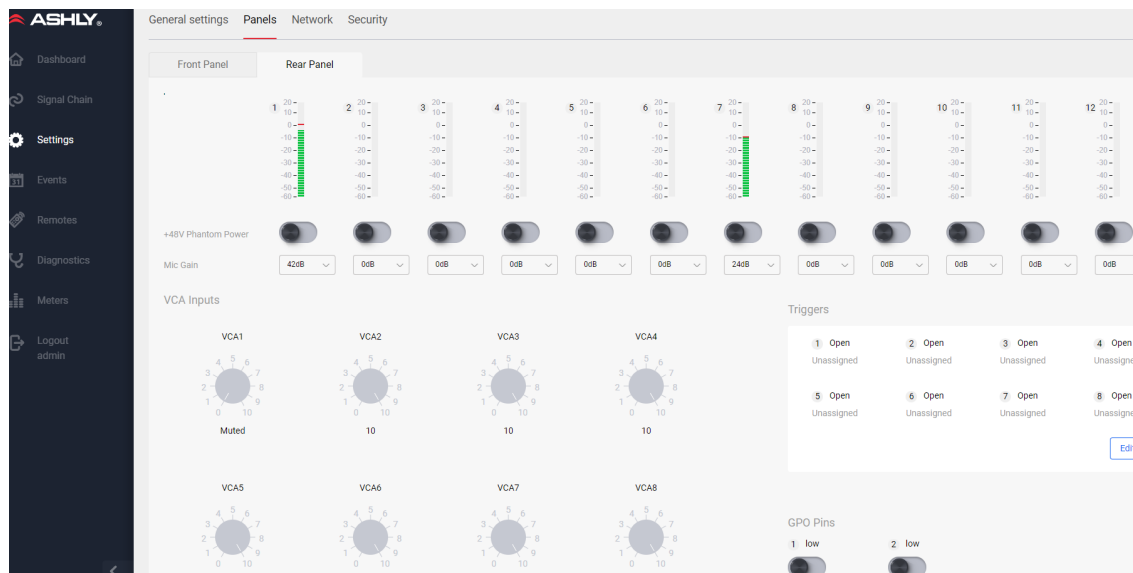

- Inputs 1-12 (per channel): Input signal LEDs, phantom power On/Off, set preamp gain
- VCA Inputs (1-8): Shows current VCA control position, full counter-clockwise mutes the VCA gain
- Trigger 1-8: Shows current trigger pin status, press [Edit] button to view all events
- GPO 1-2 pins: Set/display current GPO pin status

6.3e Settings > Network

- Network configuration can be set as automatic (DHCP) or manual (Static IP). See [section 5.5](#) for tips on using static IP.

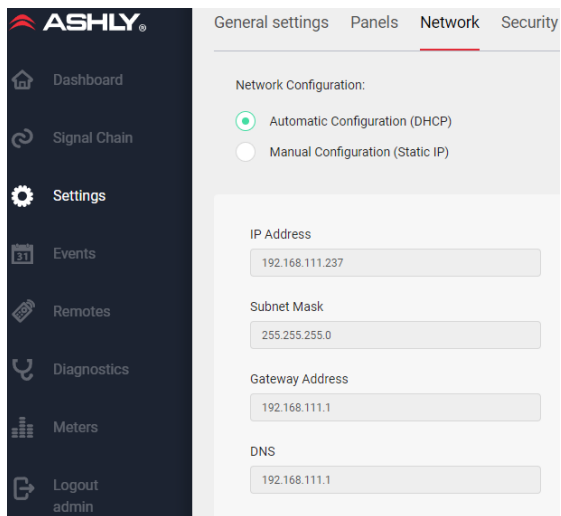

- A logged-in unit's MAC address is shown on the Settings page. The MAC address is also printed on a sticker on the AQM1208 back panel.

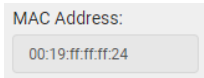

- Clicking on the "Identify Device" button on the Settings page will cause the device to visually identify itself by turning on its COM LED for 10 seconds.



6.3f Settings > Security

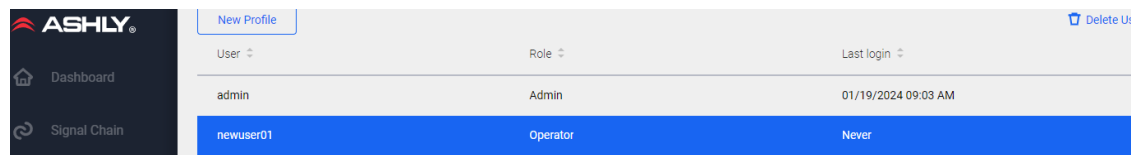

The security screen is where new users are created and granted access privileges.

New user accounts are created by an Admin using the New Profile button, then given a unique username, security role, and password.

The following roles are available:

- **Admin** always has full access. The admin name can be edited. Additional admins can be added and removed, but there must always be at least one admin.
- **Guest Admin** can be granted full access, or any combination of the following permissions:
 - Edit Accounts
 - Remote Logout
 - Edit Device Misc.
 - Event Log Clear
 - Event Scheduler edit
 - Front Panel Controls edit
 - Rear Panel Controls edit
 - Network Settings edit
 - Paging Ducking edit
 - Preset edit
 - Preset Recall
 - System Time edit
 - Trigger Settings edit
 - Edit Signal Chain
 - Import/Export Setting

- **Operator** has a different list of available permissions. Each permission must be authorized by an Admin or a Guest Admin who has "Edit Accounts" permission allowed in their profile.

Create an Operator role for deploying a Remote Mixer, Remote DCA, or Virtual WR5 Remote. ([see section 7](#)). Operator privileges can include any combination of the following permissions:

- Edit Signal Chain
 - Front Panel Controls View
 - Preset Recall
 - DCA Remote
 - Mixer 1-8 Remote
 - WR5 Remote
- **View Only** users are denied access to all controls and settings.

6.4 Events

Events can be created and then scheduled using the internal real-time-clock (RTC), or triggered by a logic input connected to rear panel Trigger Input 1-8. Multiple actions can be included in a single event. Use the delay time parameter to determine how long after the previous action the current action will occur.

Use the New Event command to create events. Events can also be cloned, edited, and deleted.

Events > Event List

All scheduled or triggered events are listed by event name, event type, and action(s). Click on any event in the list to test, clone, edit, or delete that event. New events can be added from this screen.

6.4a Events > Scheduled Events

Scheduled events are created, programmed and saved within the unit, then executed based on the real time clock. Events can be scheduled for one time, daily, weekly, or yearly.

Several actions can be grouped together in sequence, but still be part of a single scheduled event. A delay time of up to 99 seconds can be added to configure how long after the previous action the current action will occur. If delay time is added to the *first* action in sequence, the delay time is added *before* the first action.

Scheduled event action types include the following:

- Cancel Today's Events: Over-rides all other scheduled events for the day, ending at midnight.
- Channel Mute: Mutes selected input or output channels, but does not affect mixer mute.

- Channel Un-mute: Un-mutes selected channels, but does not affect mixer mute.
- GPO High: Sets GPO pin 1 or pin 2 to logic high
- GPO Low: Sets GPO pin 1 or pin 2 to logic low
- Gain Decrement / Increment: Reduces or increases the gain of selected channels by a fixed amount, up to +/- 6dB. *Note: A Gain block must first be placed on the selected channel(s).*
- Mixer Mute: Mutes selected mixer channels, but does not affect input or output channel mute.
- Mixer Un-mute: Un-mutes selected mixer channels, but does not affect input or output channel mute.
- Power Off: Turns the amplifier off
- Power On: Turns the amplifier on
- Preset Recall: Recalls one preset from device memory.
- Resume Today's Schedule: Undoes the "Cancel Today's Events" event.
- Source Select: Selects input channels for any or all mixers.
- Subpreset Recall: Recalls one sub-preset from device memory.

6.4b Events > Triggered Events

Triggered events are assigned to one of the eight rear panel contact closure trigger input pins. The event is triggered when the input pin is connected to the connector's ground pin.

Triggered event action types include the following:

- A/B Source Select: This toggles between two sets of selected input channel sources for any or all designated mixers.
- Action Sequence - Select multiple actions from one trigger input event. A delay time of up to 99 seconds can be added to configure how long after the previous action the current action will occur. If delay time is added to the *first* action in sequence, the delay time is added *before* the first action.
- Channel Mute - Selects *signal chain* inputs or outputs to be toggled as muted or unmuted, it does not affect mixer mute status.
- General Purpose Output (GPO) Toggle - For logic control of an external device, this sets GPO pin(s) low when closed, high (+5V) when open.
- Mixer Mute - Selected *mixer* channels can be toggled muted or unmuted,. Mixer mute does not affect input or output mute.
- Paging - Toggles a normally off input channel to serve as a paging input, turning it on and applying it to all assigned mixers without affecting other inputs, unless Ducking priority has been applied.
- Pause/Resume Schedules - Interrupts all scheduled events when closed, resumes all scheduled events when open.
- Preset Toggle - Toggles between one assigned preset when closed, and another preset when open.

7 Remote Control

7.1 Software Remote Control

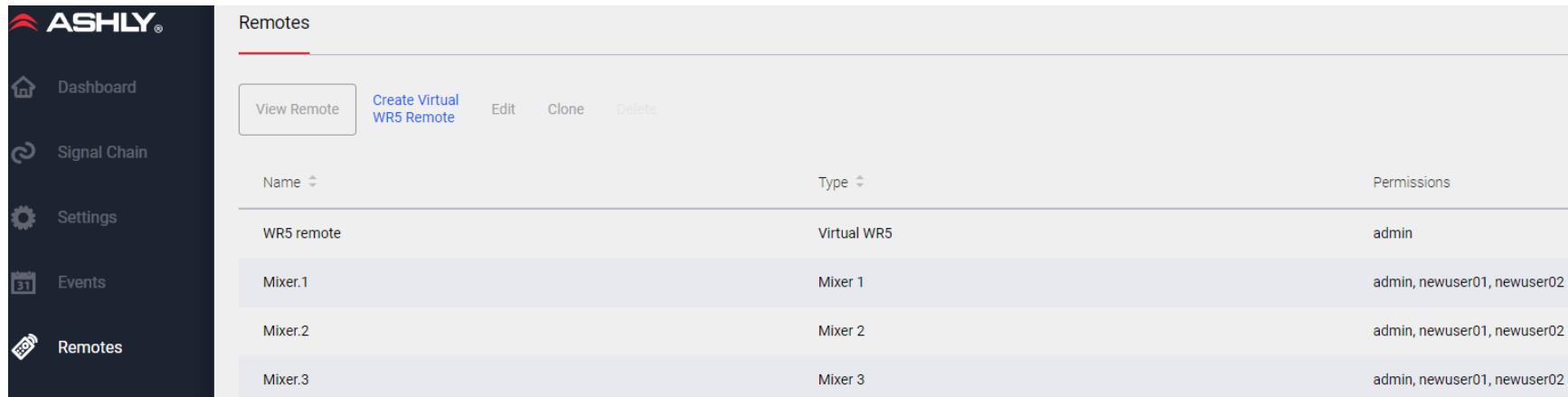

Name	Type	Permissions
WR5 remote	Virtual WR5	admin
Mixer.1	Mixer 1	admin, newuser01, newuser02
Mixer.2	Mixer 2	admin, newuser01, newuser02
Mixer.3	Mixer 3	admin, newuser01, newuser02

In the software Remotes menu, a remote mixer, DCA, or virtual WR5 can be created, configured, then deployed onto a tablet or mobile device for secure use by a remote operator.

Create a New User: To deploy a new software remote, the Admin (or guest admin) must first go to [\[Settings>Security\]](#) to create a new user profile, or edit an existing profile. The Admin assigns a Username, assigns their role (Guest Admin, Operator, or View Only), enters a password for the new user, then selects permissions to be granted. See [\[Settings>Security\]](#) for available permissions. Save the new user profile by clicking [\[Create Account\]](#).

Alternately, use [Launch Quick Setup](#) from the main dashboard page to similarly create a new user account.

All users with assigned privileges will appear in the Permissions column for each remote type.

Deploy the Remote: For all software remote deployments, the admin must select a remote type to deploy, for example "Mixer.1". Admin should then click the [\[View Remote\]](#) button. The remote Mixer.1 screen appears. This is the screen that will be seen and used by the remote user. Copy the resulting URL from the browser and send it to the remote user for them to login to the AQM1208 from their device browser*. Provide the user the password used for their account. Once they log in, they have access to the AQM1208 functions as determined by their assigned privileges.

***In order to retain the network link, the remote operator should additionally check [\[Remember Me\]](#) when first logging in.**

Note: Network connections between the remote and AQM1208 must use the same subnet.

Only an Admin can log out from a deployed remote.

See the next page for examples of all three types of software remotes.

7.1a Remote Mixers 1-8

The remote mixer grants to an operator basic level control and mixer channel mute for a specific output mixer (zone). The operator has access to the mixer assigned by the admin in the user profile.

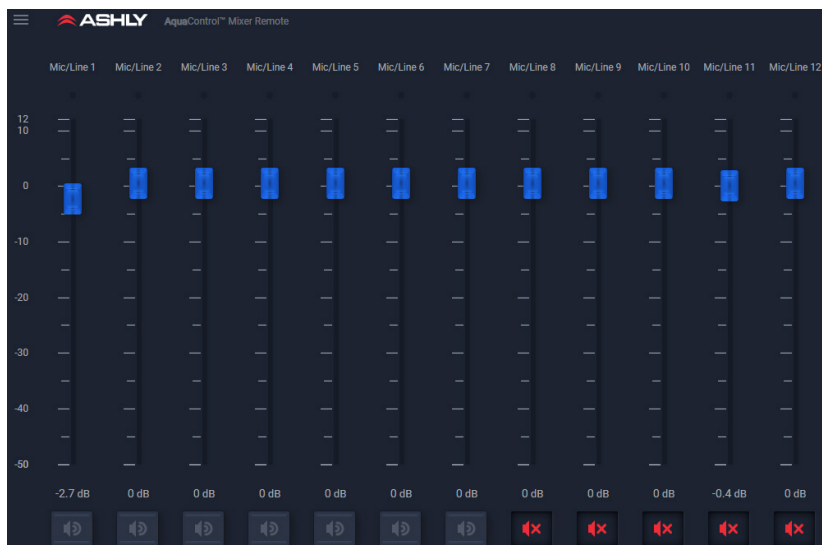

7.1b Remote DCA 1-4

DCA groups 1-4 are used to globally adjust the relative levels of all channels assigned to that group. In the DSP signal chain, a [DCA Gain](#) block must first be placed on every channel you wish to assign to a DCA group, then enabled and adjusted for each DCA group as desired.

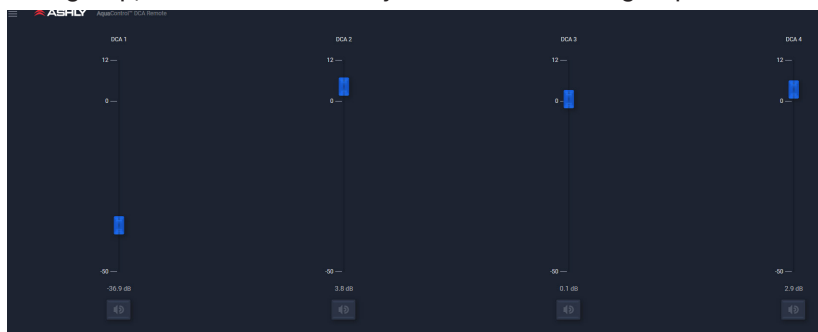

7.1c Virtual WR5 Remote

The popular Ashly WR5 is a programmable button hardware remote for other Ashly products that fits into a standard electrical box. The AQM1208 offers a virtual WR5 remote that mimics the look and feel of the original WR5, but allows customization specific to the AQM1208.

There are six programmable buttons and one fader on the virtual WR5.

Available button functions include:

- Preset Recall
- Subpreset recall
- Source Select - Mixer 1-8, inputs 1-12, with exclusive select option
- Channel Mute - Inputs 1-12, outputs 1-8
- Fader Channel Select - Mixer input gain, DCA gain, channel gain, selected source, min/max gain level
- Activate Page - Overrides selected mixer(s) settings with selected input.

Available Fader functions* include:

- Mixer Input Gain - Assign WR5 fader to mixer input gain,
- DCA gain, channel gain, selected source - DCA 1-4
- Channel Gain - input 1-12 OR output 1-8

*min/max gain limit & meter enable is available on all fader functions:

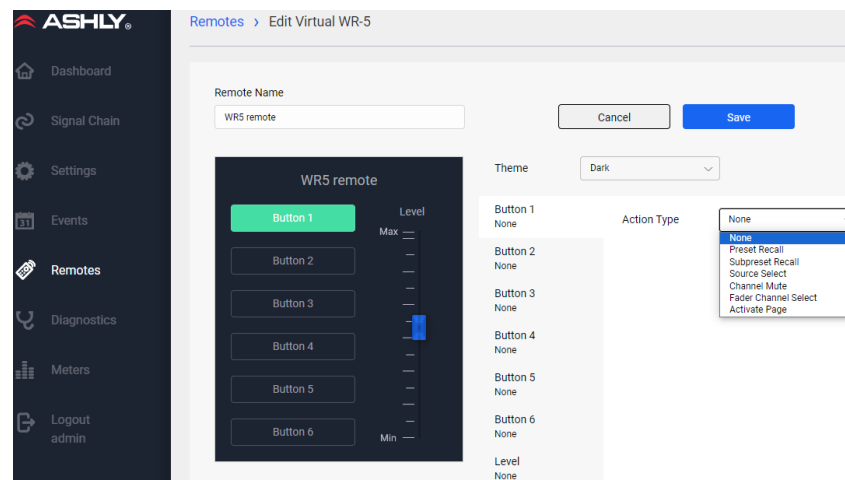

7.2 Back Panel Remote Control

7.2a VCA Level Control Inputs

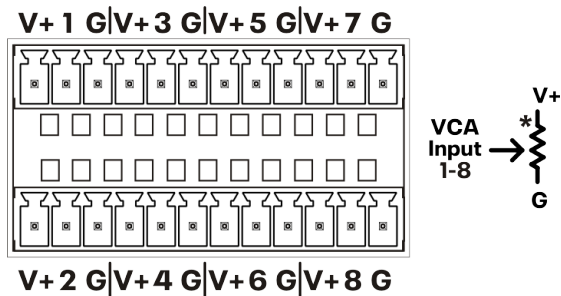

Remote DC level control is available on eight VCA (voltage controlled amplifier) inputs. A VCA Gain block must first be placed in an input or output signal chain, then assigned to a VCA input pin. Multiple VCA gain blocks can be assigned to the same VCA input pin.

Ashly WR-1, WR-1.1, or WR-1.5 remotes can be used for DC level control, or a custom control can be made using a 10k Ohm potentiometer wired as shown.

*The asterisk indicates the potentiometer's clockwise position, ie full volume.

The VCA remote level control V+ pins provide +1.8VDC. Do not use V+ for any other purpose. Connect the VCA level control potentiometer ground wire (G) only to its VCA input ground pin.

7.2b Trigger Logic Inputs

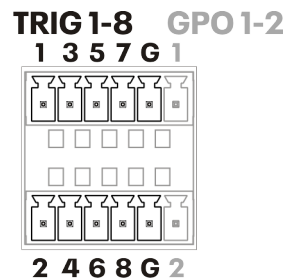

Eight programmable trigger inputs are available for contact closure events. The triggered event occurs when the trigger input pin is connected to its ground using a contact closure switch.

Triggered events get configured in the Events screen. Events can be created, cloned, edited, deleted, and tested from this

Triggered events include:

- A/B Source Select
- Action Sequence
- Channel Mute
- GPO Output Logic Toggle
- Mixer Mute
- Paging
- Pause/Resume Schedules
- Preset Toggle.

Current trigger input pin status (open or closed) can be viewed in the [Settings>Panels>Rear Panel] screen.

7.2c GPO Logic Outputs

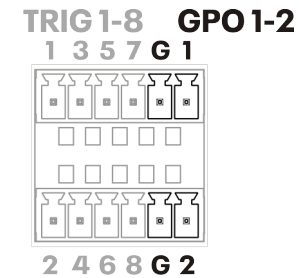

Two GPO (general purpose output) pins are available for driving external device logic inputs to effect a lighting change, motorized curtain, projector screen, etc. GPO logic status can be recalled as part of a preset, sub-preset, or changed using a scheduled or triggered event.

Current logic high/low status can be viewed or configured in the [Settings>Panels>Rear Panel] screen.

7.3 Ashly Remotes

The following Ashly hardware remotes are available for purchase from your Ashly dealer:

7.3a AquaTouch7

The AquaTouch7 is a wall-mount tablet specifically designed and used for Ashly AquaControl compatible devices. The AquaTouch7 uses a wired Ethernet connection, for complete and secure system control of the AQM1208 at the touch of a finger.

A Wi-Fi connection for AquaTouch7 is not available, it must be wired.

Once properly connected, the AquaTouch7 offers the same GUI control screens as seen on a PC or other browser device, with the added benefit of a secure, tamper-proof, and dedicated remote control device for any installation.



For more details on AquaTouch7, please visit the Ashly website.

7.3b WR-1 and WR-1.1

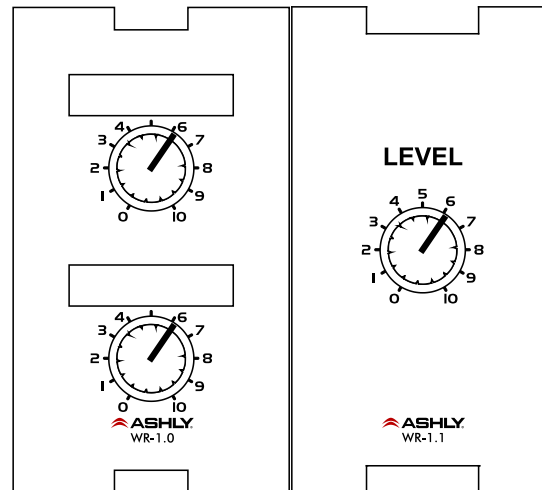

The WR-1 and WR-1.1 are remote level controllers used for DC level control inputs. The WR-1 (dual potentiometer) and WR-1.1 (single potentiometer) mount to a standard North America electrical wall box. The remote is wired to the AQM1208 Euroblock VCA pins V+, 1, 2, or 3, and ground, then associated in software with a VCA Gain block placed anywhere in the signal chain.

If using a potentiometer other than the WR-1, use 10k Ohm and wire the mXa V+ pin to the potentiometer's clockwise terminal, GND to the counter-clockwise terminal, and VCA pin 1-3 to the wiper. *Do not connect the WR-1 ground connection to any external grounds.*

7.3c WR-1.5

The WR-1.5 offers a single rotary potentiometer for DC level control, plus with a four-position rotary switch for triggering events using AQM1208 trigger inputs.

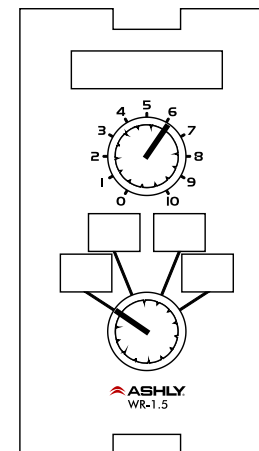

7.3d WR-2 Event Trigger Switches

The WR-2 lockout push-button remote can trigger up to four different events that have been programmed into the AQM1208. Each pushbutton switch gets connected to a trigger input pin. When a switch is pressed, it triggers the event programmed for that trigger input.

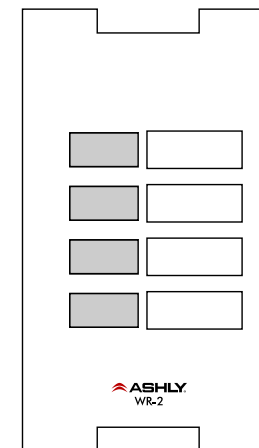

8 Meters

The Meters page shows all mic/line input channel levels, all mixer input levels, and output channel levels all on one screen.

- Mic/Line Input Channel level is sampled immediately after each input preamp gain stage, but before any input signal chain DSP functions are applied.
- Mixer Inputs displays the signal level available to all mixers *after* each input channel's DSP signal chain, but before the mixer.
- Output Channels shows the signal level present on each output channel, sampled after all output DSP signal chain functions.



9 Troubleshooting

No AC Power

- Is the detachable AC power cord properly installed? Is it plugged into a known live outlet?
- Have the front panel LEDs been disabled? (the unit can be on without any LEDs lit)
- Has power been turned off from the software or from a scheduled event?

No Network Connection

- Is the Ethernet cable fully inserted?
- Does the Ethernet jack show activity and power LEDs?
- Has the unit been properly discovered by the network, PC, tablet, or mobile device? ([see section 5](#))

No Output

- Is the unit powered on, indicated by the illuminated front panel power LED? (unless front panel LEDs have been disabled)
- Is the input signal properly wired?
- Is there input signal?
- Is an input, mixer, or output channel muted?
- Is there meter activity on the unit?
- Is there meter activity on the mixer meter page?
- Are remote gain controls or software faders turned down?

- Is the signal muted or turned down by VCA remote control or a triggered/scheduled event?
- Are dynamics or gain tool settings in the signal chain allowing signal to pass properly?
- Are filters set that band-limit the audio?
- Is a noise gate reducing the signal?
- Is signal routed to the correct output channel in the mixer matrix

Still Not Working?

- Contact Ashly technical support at 1-800-705-2102, or email service@ashly.com

Diagnostics

If experiencing a problem, it may be helpful to view the device activity log, found in the diagnostics menu. Diagnostics will monitor and record a log of user selected activity, useful for debugging system issues or viewing user activity. The log can be exported as a spreadsheet *.csv file.

The log feature can monitor and record the following activity categories and display results for a specified date range.

- Status
- Operation
- Events
- Presets
- Security
- Network

10 Dimensions

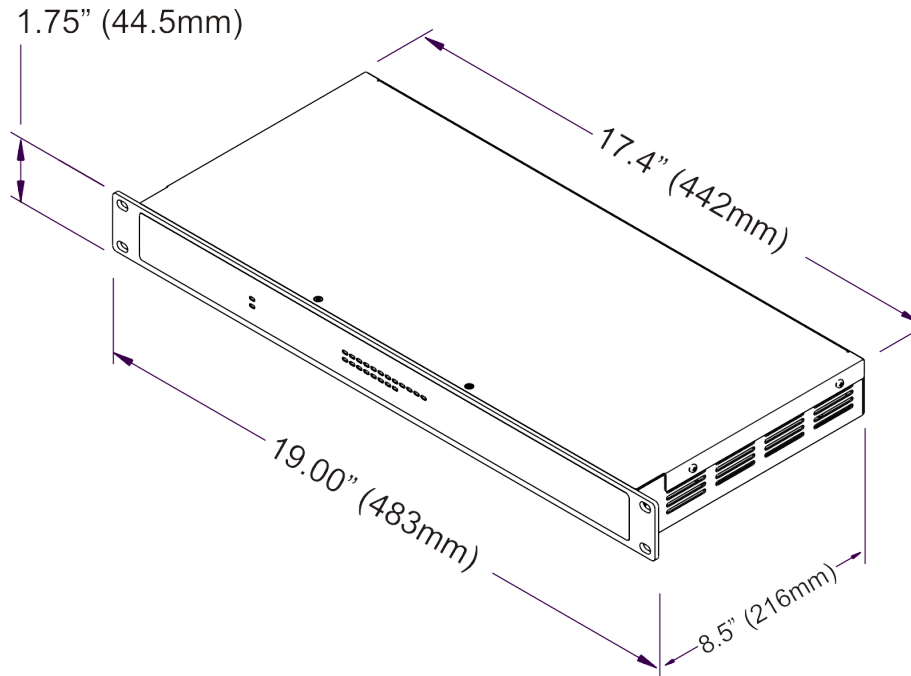

11 Specifications

General Specifications

Mic/Line Inputs	Euroblock 3.5mm
Input Impedance	Active balanced, 3k Ω
Maximum Input Level	+21dBu
Mic Preamp EIN	-126dB
Input Gain Range	0dB to +66dB
Phantom Power	+21V, 10.8mA/ch max, switchable per channel
Summed Mono Inputs	Dual RCA, unbalanced
Input Impedance	10.0K Ω
Maximum Input Level	+3.8dBv (+6dBu)
Line Outputs	Euroblock 3.5mm
Output Impedance	100 Ω
Maximum Output Level	+21dBu
Output Noise	<-90dBu, unweighted
Dynamic Range	>110dB (20Hz-20kHz, unweighted)
Distortion (THD-N, typical)	<0.01% @ 1kHz, 0dBu
Frequency Response	20Hz-20kHz, \pm 0.25dB
VCA 1-8 input	Euroblock 3.5mm, VCA pins 1-8, +1.8V, G
Trigger 1-8 contact closure input	Euroblock 3.5mm assignable function
GPO 1 & 2 general purpose logic outputs	+5V, G, Euroblock 3.5mm assignable function
Ethernet	RJ45, 100MB/1GB
Factory Reset	See section 4.3

Front Panel LED Features

Power LED	Blue, ON, OFF
Com LED	Green, ON for Ethernet activity, device ID
Input LEDs	Green/amber for signal present, Red for clipping or mute
Output LEDs	Green/amber for signal present, Red for clipping or mute

DSP Processors

Input A/D:	32 bit
Output D/A:	32 bit
DSP Processors:	32-bit floating point
Sample Rate:	48kHz
Propagation Delay	1.08 ms

Miscellaneous

Compatible Ashly Remote Control Devices	AquaTouch7 tablet, WR-1, WR-1.1, WR-1.5, WR-2
Software Control	Ashly AquaControl™ Software, served from AQM1208
Power Requirements	90-240VAC, 50/60Hz, 25W
Power Cable Connector	IEC, detachable
Unit Weight	6.2lbs (2.8kg)
Unit Dimensions	19"W x 1.75"H x 8.5"D (483 x 44.5 x 216mm)
Shipping Weight	9lbs (4.1kg)
Shipping Dimensions	23"W x 4.5"H x 12.5"D 584mm x 114mm x 318mm
Environmental	40°-120°F (4°-49°C) noncondensing
Safety/Compliance	CE, FCC Class B, RoHS, UL, CSA

Ashly AquaControl™ Software Specifications

Dashboard	
General	
Display	current device, number of inputs & outputs, firmware revision, last recalled preset
Controls	Launch Quick Setup
Signal Chain	
General	
Signal Chain Display	Editor or Diagram Mode
Global Functions	Save Preset, Save SubPreset, Clear Signal Chains, Hide Unused Channels, Mute All
Mic/Line Input Channels 1-12 (per channel)	
Phantom Power	On/Off, 21V, up to 10.8mA per channel
Preamplifier Gain	0dB to +66dB, 6dB steps
Input Mute	On/Off
Utility Functions	Copy Chain, Add Mute to Sub Preset, Save template, Load Template, Clear Chain
Summed RCA Mono Inputs 9-12 (Parallel Inputs with channels 9-12, no mic pre)	
Maximum Input Level	+11 dBu
Mixer 1-8	
Input Level Controls	-50dB to +12dB, Off
Input Level Meters	-60dBu to +20dBu
Mute	mute per channel, mute all
Route Enable	per input channel, enable/disable
Automix Assign	per input channel, enable/disable
Automix Response	0.01s to 1.2s
Ducker	per mixer, On/Off

Output Channels 1-8	
Mute	per channel, On/Off
Ducking	
Ducker	per mixer, On/Off
Available Input Channels	1-12
Priority	per channel, 1-12
Filibuster	per channel, On/Off
Threshold	-70dBu to +20dBu
Depth	per channel, 0-30dB, -inf
Hold	0-60 seconds
Release	2ms/dB to 1000ms/dB

Routing	
Available Inputs	1-12
Available Mixers	1-8
Available Outputs	1-8
Output Source Select	mixer 1-8, none

Signal Chain > Pluggable DSP Blocks

DSP functions can be linked using one of 16 link groups

Ambient Noise Compensation (outputs only)

On/Off, Compare

Compensation:	
Max Gain	-40dB to +20dB
Min Gain	-40dB to +20dB
Gain Change Rate	0.2s/dB to 20s/dB
Input Level Meter	-40dBu to +20dBu
ANC Gain Meter	-40dB to 0dB

Ambient Noise:	
Mixer Input Channel	Mic 1-8, Stereo Line 9-12
Noise Threshold	-40dBu to +20dBu
Prog/Amb Gain Ratio	0.3:1 to 3:1
Avg. Noise Meter	-40dBu to +20dBu

Autoleveler (On/Off, Compare)

Action	gentle, normal, aggressive
Target Level	-40dBu to +20dBu
Maximum Gain	0dB to +27dB
Metering	Input, Gain
Advanced Autoleveler Controls:	
Ratio	1.2:1 to 10:1
Gain Decrease Rate	5ms/dB to 1000ms/dB
Gain Increase Rate	5ms/dB to 1000ms/dB
Hold Time	0-6 sec
Threshold Below Target	-30dB to 0dB

Brick Wall Limiter (link groups not available)

On/Off, Compare

Threshold	-20dBu to +20dBu
Ratio	infinite
Attack	0.2ms/dB to 50ms/dB
Release	5ms/dB to 1000ms/dB

Compressor (On/Off, Compare)

Detector Types	Peak, Average
Attenuation Bus	none, 1-4 available
Threshold	-20dBu to +20dBu
Ratio	1.2:1 to infinite
Attack	0.2ms/dB to 50ms/dB
Release	5ms/dB to 1000ms/dB
Metering	input, output in dBFS total attenuation in dB

Crossover (outputs only)

Output Select	Line Out 1-8
Filter Frequency	20Hz-20kHz

Filter Types: (available slopes in dB/octave)

Bessel	12, 18, 24, 30, 36, 42, 48
Butterworth	6, 12, 18, 24, 30, 36, 42, 48
Butterworth/Linkwitz	Same as Butterworth 18
Linkwitz	12, 24, 36, 48
Linkwitz Notch	4th, 8th order

Ashly AquaControl™ Software Specifications

Signal Chain > Pluggable DSP Blocks

(continued)

DCA Gain (On/Off, Compare)

Level	-50dB to +12dB
Polarity	normal, inverted

DCA Groups 1-4 (per group):

Level	-50dB to +12dB
Mute	On/Off
Enable for channel	On/Off

Delay (On/Off, Compare)

Delay Time	0-682 ms
Delay Length (at 22°C)	0-770 ft, 0-235 m
Temperature Compensation	-30°F to +150°F (-34°C to +65°C)

Feedback Suppressor (inputs 1-8 only)

On/Off, Compare

Filters	12
On/Off per filter	yes
Single/global filter lock	yes
Detector Sensitivity	five levels
Flatten All Filters	yes
Flatten Floating Filters	yes
Filter Type	notch, parametric
Filter Modes	restricted, floating, manual
Float Time	5 seconds to 24 hours
Filter Frequency	20Hz-20kHz
Filter Level:	
Notch filter	-∞
Parametric	-30dB to +15dB
Filter Bandwidth (Q)	0.016 to 3.995 oct, (90 to 0.267 Q)

FIR Filter (outputs only)

Add FIR File, On/Off, Compare

Sample Rate	48kHz
Number of Taps	up to 512
Loadable File Types	*.csv, *.fir

Gain (On/Off, Compare)

Range	-50dB to +12dB, polarity invert
-------	---------------------------------

Gate (On/Off, Compare)

Threshold	-80dBu to +20dBu
Attack	0.2ms/dB to 50 ms/dB
Range	0dB to 100dB, off
Release	5ms/dB to 1000ms/dB
Metering	Key Signal

Advanced Gate Controls:

Key Frequency	20Hz-20kHz
Key Bandwidth	0.016 to 15 oct

High Pass Filter (On/Off, Compare)

Filter Types: (available slopes in dB/octave)

Bessel	12, 18, 24, 30, 36, 42, 48
Butterworth	6, 12, 18, 24, 30, 36, 42, 48
Butterworth/Linkwitz	18
Linkwitz-Riley	12, 24, 36, 48
Linkwitz Notch	24, 48

Low Pass Filter (On/Off, Compare)

Filter Types: (available slopes in dB/octave)

Bessel	12, 18, 24, 30, 36, 42, 48
Butterworth	6, 12, 18, 24, 30, 36, 42, 48
Butterworth/Linkwitz	18
Linkwitz-Riley	12, 24, 36, 48
Linkwitz Notch	24, 48

Parametric Equalizer (On/Off, Compare)

Number of filter bands	10
------------------------	----

Filter Types:

Parametric	
Frequency	20-20kHz
Level	-30dB to +15dB
Bandwidth	0.016 to 3.997 oct

Hi or Low Shelf, 6 or 12 dB

Frequency	20Hz-20kHz
Level	-30dB to +15dB

All Pass

Frequency	20Hz-20kHz
-----------	------------

Variable Q HP/LP

Frequency	20Hz-20kHz
Bandwidth	0.016 to 3.997 oct

Notch

Frequency	20Hz-20kHz
Bandwidth	0.016 to 3.997 oct

Bandpass

Frequency	20Hz-20kHz
Bandwidth	0.016 to 3.997 oct

Signal Generator (On/Off, Compare)

Signal Type	pink noise, white noise, sine wave
Signal Level:	off, -50dBu to +12dBu
Sine Wave Frequency	20Hz-20kHz

VCA Gain (Compare)

Controls	On/Off, VCA 1-8, position
----------	---------------------------

Linking

Most DSP functions can be linked to 1 of 16 link groups

Ashly AquaControl™ Software Specifications

Settings Specifications

General Settings

Firmware	current version, update
Device Name	user editable
Group Name	user editable
Real Time Clock	Automatic/Manual
Time Zone Set	yes, UTC referenced
Time Format	24 hour, 12 hour
Import All Settings	yes
Export All Settings	yes

Panels - Front Panel Settings

Enable LEDs	On/Off
Power On/Off	On/Off

Panels - Rear Panel Settings

Mic Input 1-12	Input level LED display, Phantom power On/Off, mic gain setting
VCA Inputs 1-8	current potentiometer position shown
Trigger Inputs 1-8	open/closed status, assigned/unassigned status
GPO Pins 1-2	displays/sets GPO pin status as low or high

Network Settings

Network Configuration	automatic (DHCP), manual (static IP)
IP Information	IP Address, Subnet Mask, Gateway Address, DNS
MAC Address	shown when logged in
Identify Device Button	lights COM LED for 10s

Security Settings

User Profile	create, delete user
Profile Roles	Admin, Guest Admin, Operator, View Only

Event Specifications

Event features	Test event, new event, clone, edit, delete
Scheduled Events	None, Cancel Today's Events, Channel Mute, Channel Un-Mute, GPO High, GPO Low, Gain Decrement, Gain Increment, Mixer Mute, Mixer Un-Mute, Power Off, Power On, Preset Recall, Resume Today's Scheduled Events, Source Select, Sub Preset Recall
Triggered Events	A/B Source Select toggle, Action Sequence, Channel Mute toggle, GPO Toggle, Mixer Mute toggle, Paging toggle, Pause/Resume Schedules, Preset Toggle

Remotes Specifications

Deployable Remote Types	Mixer 1-8, DCA, virtual WR5
Remotes Page Functions	View remote, create virtual WR remote, edit, clone, delete WR5
Virtual WR5 features	Remote name, programmable buttons 1-6, programmable fader, light/dark theme

Virtual WR5 Button Actions	None, preset recall, subpreset recall, source select, channel mute, fader channel select, activate page
----------------------------	---

Virtual WR5 Fader Actions	None, mixer input gain, DCA gain, Channel gain
---------------------------	--

Diagnostics Specifications

Log Functions	Log report date limit, log type select, select all, clear log, export log
---------------	---

Log Types	Status log, operation, event, preset, security, network
-----------	---

Meters Specifications

Input Channel Meters	dBu, post mic preamp gain, pre DSP
Mixer Input Meters	dBu, post input DSP, pre mixer input
Output Channel Meters	dBu, post mixer, post output DSP

LIMITED WARRANTY (USA ONLY)

(Other countries please contact your respective distributor or dealer.)

For units purchased in the USA, warranty service for this unit shall be provided by ASHLY AUDIO in accordance with the following warranty statement.

ASHLY AUDIO, an **exertis|JAM** business, warrants to the owner of this product that it will be free from defects in workmanship and materials for a period of FIVE years from the original-date-of-purchase, with the exception of touch-screen displays and motorized faders which are warranted for THREE years from the original-date-of-purchase.

ASHLY AUDIO will without charge, repair or replace at its discretion, any defective product or component parts upon prepaid delivery of the product to the ASHLY AUDIO factory service department, accompanied with a proof of original-date-of-purchase in the form of a valid sales receipt. This warranty gives you specific legal rights, and you may also have other rights, which vary from state to state.

EXCLUSIONS: This warranty does not apply in the event of misuse, neglect, or as a result of unauthorized alterations or repairs made to the product. This warranty is void if the serial number is altered, defaced, or removed. ASHLY AUDIO reserves the right to make changes in design, or make additions to, or improvements upon, this product without any obligation to install the same on products previously manufactured.

Any implied warranties, which may arise under the operation of state law, shall be effective only for FIVE years (THREE years for touch-screen displays and motorized faders) from the original-date-of-purchase of the product. ASHLY AUDIO shall be obligated to only correct defects in the product itself. ASHLY AUDIO is not liable for any damage or injury, which may result from, or be incidental to, or a consequence of, such defects. Some states do not allow limitations on how long an implied warranty lasts, or the exclusion, or limitation of incidental or consequential damages, so the above limitations or exclusions may not apply to you.

OBTAINING WARRANTY SERVICE:

For warranty service in the United States, please follow this procedure:

1) Contact the Ashly Service Department at 800-705-2102 or <https://ashly.com/technical-support/> to receive an RMA number. You must receive a RMA from the Service Department before sending your unit to Ashly.

2) Return the product to ASHLY AUDIO freight prepaid, with a written statement describing the defect and application that the product is used in. ASHLY AUDIO will examine the product and perform any necessary service, including replacement of defective parts, at no further cost to you.

3) Ship your product to:

ASHLY AUDIO

Service - RMA (insert RMA#)

847 Holt Road

Webster, NY 14580-9103

ASHLY AUDIO 847 Holt Road Webster, NY 14580-9103, USA

Phone: (800) 705-2102 Fax: (585) 872-0739

www.ashly.com

An **exertis** | **JAM** business

©2024 Ashly Audio. All rights reserved worldwide.

All features, specifications, and graphical representations are subject to change or improvement without notice.

All trademarks represented herein are the property of their respective owners.

